

OEM LIGHTING CATALOG



QUALITY.

INNOVATION.

DESIGN.

MISSION STATEMENT

HERE AT UNITED PACIFIC, we are dedicated to providing today's drivers with innovative and exciting products that deliver exceptional performance and value. Because United Pacific's continuing success depends on our customer's satisfaction, we constantly push our designers and engineers to upgrade our facilities and processes in order to bring products of superior quality and reliability to the market. We at United Pacific promise to continue our passionate pursuit to be the first in:

QUALITY, INNOVATION AND DESIGN.

QUALITY

With over 30 years of experience in the heavy duty trucking industry, United Pacific Industries understand the rigors and stresses that our products are subjected to on the road. It is our mission to provide our customers with products of superior quality and reliability. In achieving this goal, United Pacific only partners with manufacturing facilities that conforms to our quality control requirements and standards. Our manufacturing partners meet or exceed ISO-9001 requirements. In addition, United Pacific's manufacturing partners must be equipped on site to perform the following quality assurance tests:

- AGING TEST
- AIR TIGHT TEST
- DUST TEST
- FLUX TEST
- PHOTOMETRIC TEST
- PULL FORCE TEST
- RAIN TEST
- SALT SPRAY TEST
- SHOCK TEST
- TEMPERATURE TEST
- HUMIDITY TEST
- VIBRATION TEST



United Pacific's manufacturing partners must maintain a track record of consistent quality and low product failure rate. Furthermore, our internal quality control structure allows us to function as the final quality control station prior to shipping. With the assistance of 3D computer technology, United Pacific can adhere to strict quality control standards during prototype creation and the production process. Our engineers and technicians perform a battery of tests to ensure that our products meet the demands of today's drivers and our goal to be first in quality.





ABOUT US

DESIGN

Located near some of the nation's most progressive automotive design centers, United Pacific established the UP Design Studio in 2002 to consolidate our position as the design leader in the heavy duty trucking industry. UP Design Studio utilizes the latest generation of computer aided design (CAD) and studio/graphic software. The design studio is equipped with the newest computers and rapid prototyping systems. In addition, UP Design Studio is staffed by graduates from the nation's most prestigious design colleges.

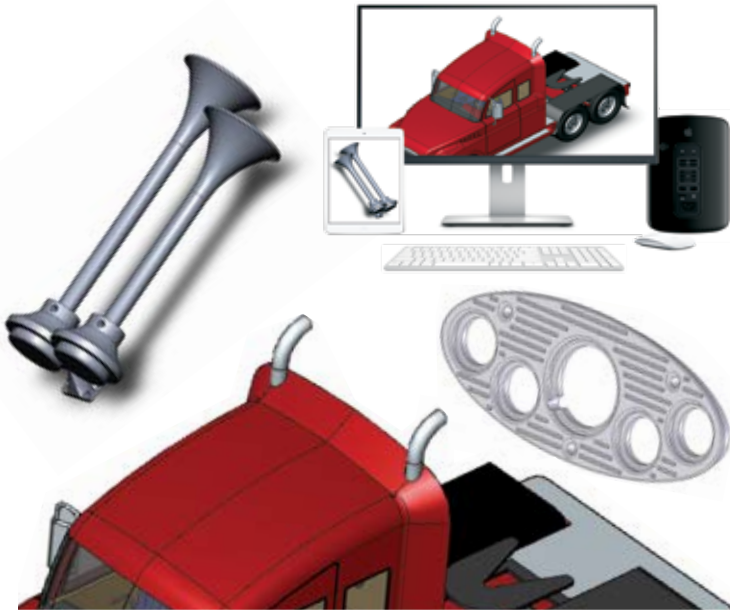

Unlike our competitors, United Pacific's design and manufacturing capabilities mean that we carry more new and original items than our competitors. The establishment of the design studio will enable us to generate even more new products with significant shorter concept-to-shelf time. The reduction in development cost mean that we can develop products utilizing design based development processes. Design based product development allows United Pacific to create new product concepts based on designs incorporating driver demands and needs instead of economic considerations. United Pacific's emphasis on design distinguishes and positions us ahead of our competitors.

HOW TO ORDER

To order from United Pacific Industries, you must be an authorized dealer, distributor or OEM.

If you are not authorized to stock and sell United Pacific products, you must order through an authorized dealer. Please call 1 (800) 790-6988 for more information.

CONTACT US

United Pacific customer service representatives are available from:

8 am - 4:30 pm PST

Toll Free: 1 (800) 790-6988
Fax: 1 (888) 986-5988
Email: sales@uapac.com
Website: www.uapac.com

INNOVATION

Known as the leader in innovation, United Pacific is dedicated to be the first to bring new and exciting products to the market. United Pacific's global expertise allows us to search the globe for new ideas and concepts. Not only do we search the globe for new products, United Pacific invest a significant amount of resources into our own research and development efforts. With the assistance of advance 3D scanning technology, our engineers and designers can acquire accurate and precise data in seconds. The 3D data allows United Pacific to verify designs, perform quality assurance tests, and reverse engineer with unprecedented speed and accuracy. Digital inspection contributes to the early detection of shape problems, provides rapid feedback on design, and eliminates unnecessary work in downstream processes. Our rapid prototyping facility permits us to have a concept-to-shelf time of less than 5 months. In addition, United Pacific's 3D printing capabilities permit our designers to have physical models of their design concepts in hours. The physical models allow our designers and marketing staff to evaluate and test the viability of different design ideas. Our rapid prototyping facility allow United Pacific to compress design cycles, improve manufacturing planning, shorten concept-to-shelf time, most importantly, generate new and innovative products.





WARRANTY

With LED (Light Emitting Diodes) rated at 100,000 hours of operation and solid-state construction, United Pacific's LED lights are extremely reliable and durable. Purchase with confidence, United Pacific offers a complete line of LED lighting products with extended warranties. Please see the warranty policy page for more details.



INVENTORY & SHIPPING

United Pacific carries over 20,000 items in our California distribution center. No other company in the heavy duty trucking industry can match United Pacific in the variety and range of in-stock inventories. With an order fill rate of over 98.5%, United Pacific is the largest and most reliable supplier in the industry. Our shipping department ships 96.8% of all orders within 24 hours and 98.9% within 48 hours. United Pacific's vast inventory and prompt shipping has made United Pacific the only source for our customer's chrome and lighting needs.

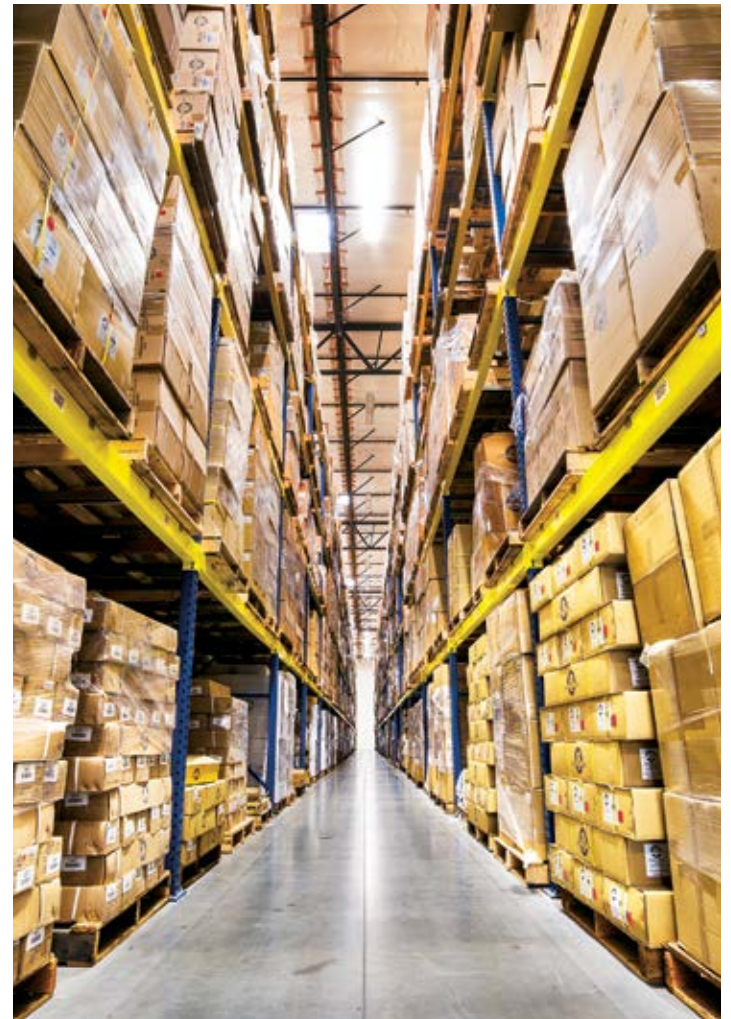

ASSEMBLED IN U.S.A.

United Pacific strives to provide today's drivers with innovative and exciting products that deliver exceptional performance and value. With our international background and expertise, we search the globe for the best and most reliable products. However, as an American company, we believe and support the American way of life. Look for the "Assembled in the USA" label on many of our products. Although the components are manufactured overseas, the products, bearing the "Assembled in the USA" labels, are hand assembled with pride in the United States.

Hard at Work for Our Customers. Hard at Work for the Environment



United Pacific
132,000 sq ft
Distribution Center
Long Beach, CA

100% reduction in potable water used for landscaping

40% reduction in total energy use due to high-efficiency mechanical and lighting systems

82% of construction waste was diverted from landfills

LEED ACCOMPLISHMENTS

Sustainable Sites

- On-site bicycle storage, showers and changing areas for company employees
- Preferred parking for low-emitting, fuel-efficient and carpool vehicles
- Stormwater is infiltrated on-site and treated to remove contaminants to reduce environmental impact on local waterways

Water Efficiency

- In addition to using reclaimed water, drought-tolerant plants and a high-efficiency irrigation system were installed to reduce the use of potable water for irrigation by 100%
- High-efficiency water closets, lavatory faucets, and showers were used to reduce annual water use by 30%

Energy and Atmosphere

- Efficient HVAC equipment and a lighting system with daylight controls reduces energy consumption by over 30%
- Enhanced commission verifies that the building's energy and water-related systems are performing as intended by the initial design

Materials and Resources

- Over 81% of construction and demolition waste was diverted from landfills

Indoor Environmental Quality

- Building ventilation system was designed to provide enhanced levels of fresh outside air to building occupants
- Interior finishes (paints, sealants, adhesives, coatings, carpet systems and composite wood) were selected with low levels of volatile organic compounds (VOCs) to reduce indoor air contamination

TABLE OF CONTENT

OEM LIGHTING CATALOG

WHAT'S NEW	1
LED PRODUCTS	
LED CLEARANCE/MARKER LIGHT	6
LED S/T/T, P/T/C LIGHTS	15
LED LIGHT BAR	24
LED BACK-UP & LICENSE LIGHTS	26
LED WORKLIGHTS	31
LED ACCESSORY/INTERIOR LIGHT	39
INCANDESCENT PRODUCTS	
INCANDESCENT CLEARANCE MARKERS	41
INCANDESCENT S/S/T, P/T/C LIGHT	46
INCANDESCENT IDENTIFICATION LIGHT BAR	51
INCANDESCENT BACK-UP & LICENSE LIGHT	52
SPECIALTY LIGHTING	55
REFLECTOR	56
ACCESSORIES	
MOUNTING ACCESSORIES	58
ELECTRICAL ACCESSORIES	63
REFERENCES	
FEDERAL REGULATION REFERENCE	71
TERMS, CONDITIONS & POLICIES	77
PRODUCT INDEX	81

21 LED 4" S/T/T & P/T/C Flanged - GLO Light

DESCRIPTION

- 21 LED 4" S/T/T & P/T/C "GLO" Light
- Unique Patented "GLO" Design, Halo Effect on Running, All LEDs Lit on Stop
- 3 Contact Female Terminal, Available in Color or Clear Lens
- Recommended Plug: Item # 34212/34216, **Lifetime Warranty**

Item #	LEDs	Lens	Pack	Carton
36958B	21 Amber	Amber	1 Pc.	20/Carton
36957B	21 Red	Red	1 Pc.	20/Carton

GloLight.
Stand Out



18 LED 4" Round - GLO Light

DESCRIPTION

- 18 LED 4" S/T/T & P/T/C "GLO" Light
- Unique Patented "GLO" Design, Halo Effect on Running, All LEDs Lit on Stop
- 3 Contact Female Terminal
- Recommended Plug: Item # 34212/34216, **Lifetime Warranty**

Item #	LEDs	Lens	Pack	Carton
36923B	18 Amber	Amber	1 Pc.	20/Carton
36922B	18 Red	Red	1 Pc.	20/Carton
36923BAK	18 Amber	Amber	1 Kit	20/Carton
36922BRK	18 Red	Red	1 Kit	20/Carton

GloLight.
Stand Out

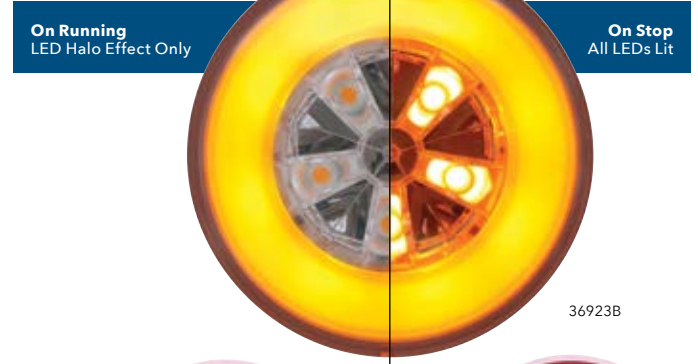

22 LED 6" Oval - GLO Light

DESCRIPTION

- 22 LED 6" S/T/T & P/T/C "GLO" Light
- Unique Patented "GLO" Design, Halo Effect on Running, All LEDs Lit on Stop
- 3 Contact Female Terminal
- Recommended Plug: Item # 34212/34216, **Lifetime Warranty**

Item #	LEDs	Lens	Pack	Carton
36925B	22 Amber	Amber	1 Pc.	20/Carton
36924B	22 Red	Red	1 Pc.	20/Carton
36925BAK	22 Amber	Amber	1 Kit	20/Carton
36924BRK	22 Red	Red	1 Kit	20/Carton

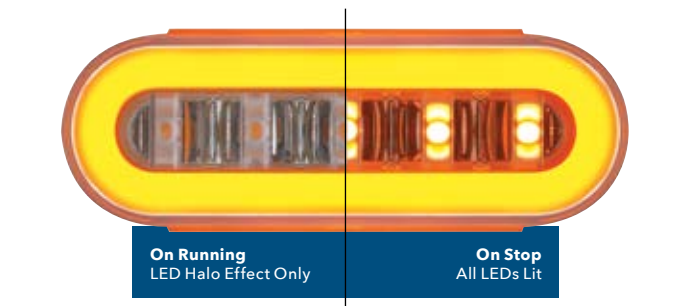

7 LED 4" S/T/T - Competition Series Light

DESCRIPTION

- 7 LED 4" "Competition Series" S/T/T Light
- Recommended Plug: Item # 34212/34216, **Lifetime Warranty**

Item #	LEDs	Lens	Pack	Carton
39119B	7 Amber	Amber	1 Pc.	20/Carton
39117B	7 Red	Red	1 Pc.	20/Carton
39119BAK	7 Amber	Amber	1 Kit	20/Carton
39117BRK	7 Red	Red	1 Kit	20/Carton



COMPETITION
SERIES



20 LED 4" Back-Up - Competition Series Light

DESCRIPTION

- 4" Back-Up Light with 20 Super White LED
- Epoxy Sealed, Specially Designed Lens, 3 Contact Female Terminal
- Recommended Plug: Item # 34212/34216, **Lifetime Warranty**

Item #	LEDs	Lens	Pack	Carton
36680B	20 White	Clear	1 Pc.	20/Carton
36680BCK	20 White	Clear	1 Kit	20/Carton



COMPETITION
SERIES



20 LED 6" Oval Back-Up Light - Competition Series

DESCRIPTION

- 6" Oval Back-Up Light with 20 Super White LED
- Epoxy Sealed, Specially Designed Lens, 3 Contact Female Terminal
- Recommended Plug: Item # 34212/34216, **Lifetime Warranty**

Item #	LEDs	Lens	Pack	Carton
36679B	20 White	Clear	1 Pc.	20/Carton
36679BCK	20 White	Clear	1 Kit	20/Carton



COMPETITION
SERIES

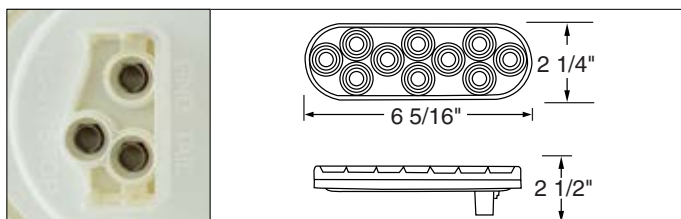

7 LED 6" Oval S/T/T Light

DESCRIPTION

- 6" Oval S/T/T Light with 7 Red LED
- Available in Red or Clear Lens, 3 Contact Female Terminal
- Recommended Plug: Item # 34212/34216, **Lifetime Warranty**

Item #	LEDs	Lens	Pack	Carton
36855B	7 Red	Red	1 Pc.	20/Carton
36855BRK	7 Red	Red	1 Kit	20/Carton



COMPETITION
SERIES

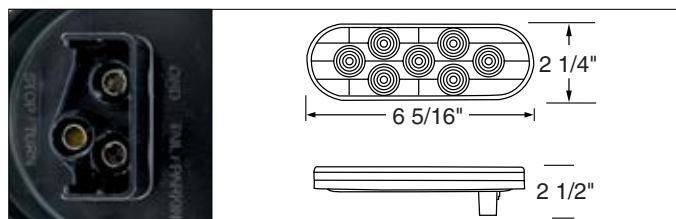



8 LED 2 1/2" Clearance / Marker Light - Reflectorized Lens

DESCRIPTION

- 8 LED 2 1/2" Clearance / Marker Light with Reflectorized Lens
- Kit Includes 2 1/2" Lamp, Rubber Grommet (Item # 31503) and Plug (Item # 34210), **Lifetime Warranty**

Item #	LEDs	Lens	Pack	Carton
38455B	8 Amber	Amber	1 Pc.	20/Carton
38456B	8 Red	Red	1 Pc.	20/Carton
38455BAK	8 Amber	Amber	1 Kit	20/Carton
38456BRK	8 Red	Red	1 Kit	20/Carton

6 LED Fender Mount Clearance / Marker Light

DESCRIPTION

- 6 LED Fender Mount Clearance / Marker Light
- Dual Color Lens with 3 Amber and 3 Red LEDs
- Kit Includes LED Light and Mounting Bracket (Item # 33006), **Lifetime Warranty**

Item #	LEDs	Lens	Pack	Carton
36774B	6	Amber / Red	1 Pc.	20/Carton
36774BARK-B	6	Amber / Red	1 Kit	20/Carton

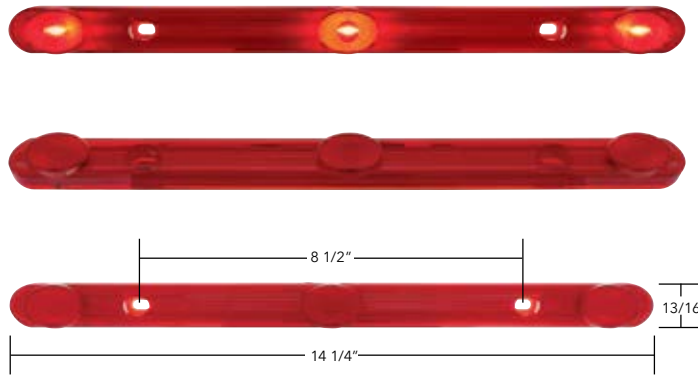

3 LED 14 1/4" ID Light Bar

DESCRIPTION

- 3 LED 14 1/4" ID Light Bar
- 2 Wire Hardwired
- Mounting Holes are 8 1/2" Apart, **Lifetime Warranty**

Item #	LEDs	Lens	Pack	Carton
38479B	3 Red	Red	1 Pc.	20/Carton

49" High Power LED Warning Light Bar

DESCRIPTION

- 49" High Power LED Warning Light Bar, 12V - 24V Application, 26 Flash Pattern
- 3 LED Fresnel Optics for Front / Rear Lighthoods and 6 LED Large D-Fuser for Corner Lighthoods
- SAE J845, Class 13, IPX 4 Rated
- Available with 8 (4 Inboards) Lighthoods, 12 (8 Inboards) Lighthoods, or 16 (12 Inboards) Lighthoods
- Brackets Required for Installation, Includes Standard Bolt / Strap Mount Bracket

Item #	Length	LEDs	LED Heads	Pack
36668	49"	36	8	1 Pc./Box
36669	49"	48	12	1 Pc./Box
36670	49"	60	16	1 Pc./Box



36668 - 8 LED Lighthoods



36669 - 12 LED Lighthoods



36670 - 16 LED Lighthoods

**SAE J845
Class 13**

**IPX 4
Rated**

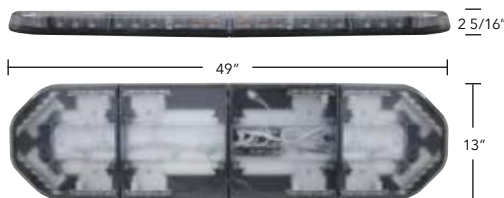

Standard Bolt / Strap Mount

High Power LED Light Bar - Curved

DESCRIPTION

- 3W High Power Double Row, Curved LED Light Bar
- 10V - 30V Application, IP 67 Rated
- 3" Tall 3 7/8" Wide, Light is 4 3/4" Tall with Mounting Bracket
- Available in 6 Different Lengths, Heavy Duty Aluminum Housing, **3 Years Warranty**



Item #	LEDs	Lumens	Length	Pack
36763	12	2160 lm	8"	1 Pc./Box
36764	24	4320 lm	14"	1 Pc./Box
36765	40	7200 lm	24"	1 Pc./Box
36766	60	10800 lm	32"	1 Pc./Box
36767	80	14400 lm	42"	1 Pc./Box
36768	96	17280 lm	50"	1 Pc./Box

High Power LED Light Bar - Competition Series

DESCRIPTION

- 3W High Power LED Light Bar
- 10V - 30V Application, IP 67 Rated
- 3 1/4" Tall, 3 1/2" Wide. Light is 4 3/8" Tall with Mounting Bracket
- Available in 5 Different Lengths, Heavy Duty Aluminum Housing, **3 Years Warranty**

COMPETITION SERIES



Item #	LEDs	Lumens	Length	Pack
36640	12	2520 lm	10"	1 Pc./Box
36641	24	5040 lm	16"	1 Pc./Box
36642	40	8400 lm	24"	1 Pc./Box
36643	60	12600 lm	34"	1 Pc./Box
36644	80	16800 lm	44"	1 Pc./Box

High Power 4 Row LED Light Bar - Reflector Series

DESCRIPTION

- 1.5W High Power LED, 4 Row LED Light Bar
- 10V - 24V Application, Reflector Illumination. IP 67 Rated
- 3 1/8" Tall x 2 1/4" Wide, Light is 5 1/8" Tall with Mounting Bracket
- Available in 6 Different Lengths, Heavy Duty Aluminum Housing, **3 Years Warranty**

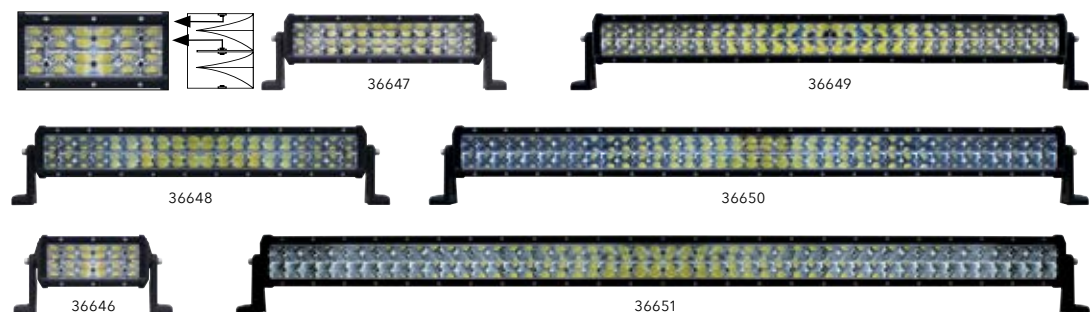

Item #	LEDs	Lumens	Length	Pack
36646	24	2160 lm	8"	1 Pc./Box
36647	48	4320 lm	14"	1 Pc./Box
36648	80	7200 lm	22"	1 Pc./Box
36649	120	10800 lm	32"	1 Pc./Box
36650	160	14400 lm	42"	1 Pc./Box
36651	200	18000 lm	52"	1 Pc./Box

Item #	LEDs	Lumens	Length	Pack
36781	12	2640 lm	7 1/2"	1 Pc./Box
36782	24	5280 lm	13 1/2"	1 Pc./Box
36783	40	8800 lm	21 1/2"	1 Pc./Box
36784	60	13200 lm	31 1/2"	1 Pc./Box
36785	80	17600 lm	41 1/2"	1 Pc./Box
36786	96	21120 lm	50 1/2"	1 Pc./Box

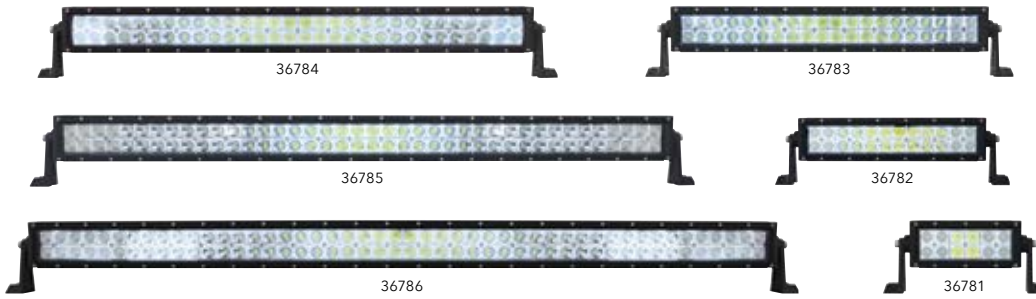

High Power Double Row LED Light Bar

DESCRIPTION

- 3W High Power "Cree" LED, Double Row LED Light Bar
- 12V - 24V Application, IP 67 Rated
- Manufactured with USA Made "Cree" LEDs
- 3 1/8" Tall x 3 1/2" Wide, Light is 4 3/4" Tall with Mounting Bracket
- Available in 6 Different Lengths, Heavy Duty Aluminum Housing, **3 Years Warranty**

Item #	LEDs	Lumens	Length	Pack
36634	6	1260 lm	4"	1 Pc./Box
36635	12	2520 lm	7"	1 Pc./Box
36636	18	3780 lm	9"	1 Pc./Box
36637	24	5040 lm	13"	1 Pc./Box
36638	30	6300 lm	18"	1 Pc./Box
36639	36	7560 lm	20"	1 Pc./Box

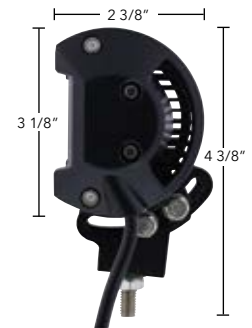

High Power LED Light Bar - Stud Mount

DESCRIPTION

- 3W High Power LED Light Bar
- 10V - 30V Application, IP 67 Rated
- 3 1/8" Tall, 2 3/8" Wide. Light is 4 3/8" Tall with Mounting Bracket
- Available in 6 Different Lengths, Heavy Duty Aluminum Housing, **3 Years Warranty**

UP's **NEW** TRUCK WEBSITE
truck.uapac.com

We've redesigned the United Pacific Truck Website! Same great products you've come to expect, now easier to find with an updated interface.

Find products quicker using categories, makes and models, or simply type in a search term. Browse through thousands of our most popular products quickly, or leaf through our catalogs and flyers to find what you're looking for.



LED CLEARANCE/ MARKER LIGHT

3 LED Mini Clearance/Marker Light

DESCRIPTION

- 3 LED Mini Clearance/Marker Light
- Requires a 13/16" Opening, Grommet Mount, 7 1/2" Wire Lead
- Available in Amber, Blue, Red or White LED with Colored or Clear Lens
- Stainless Bezel Available Separately: UP Item # 20527B, **Lifetime Warranty**

Item #	LEDs	Lens	Pack	Carton
39767B	3 Amber	Amber	1 Pc.	20/Carton
39768B	3 Red	Red	1 Pc.	20/Carton
39772B	3 White	Clear	1 Pc.	20/Carton



6 LED 2" Clearance/Marker Light - GLO Light

DESCRIPTION

- 6 LED 2" Clearance/Marker "GLO" Light
- Available in Colored or Clear Lens with 2 Female Terminals
- Recommended Plug: Item # 34210, **Lifetime Warranty**

Item #	LEDs	Lens	Pack	Carton
37035B	6 Amber	Amber	1 Pc.	20/Carton
37036B	6 Red	Red	1 Pc.	20/Carton
37035BAK	6 Amber	Amber	1 Kit	20/Carton
37036BAK	6 Red	Red	1 Kit	20/Carton



GloLight.
Stand Out



9 LED 2" Clearance/Marker Light - Reflector

DESCRIPTION

- 9 LED 2" Clearance/Marker Light with Reflector
- Available in Colored or Clear Lens with 2 Female Terminals
- Recommended Plug: Item # 34210, **Lifetime Warranty**

Item #	LEDs	Lens	Pack	Carton
38849B	9 Amber	Amber	1 Pc.	20/Carton
38850B	9 Red	Red	1 Pc.	20/Carton
38849BAK	9 Amber	Amber	1 Kit	20/Carton
38850BRK	9 Red	Red	1 Kit	20/Carton



7 LED 2" Clearance/Marker Light - Reflector

DESCRIPTION

- 7 LED 2" Clearance/Marker Light with Reflector
- Available in Colored or Clear Lens with 2 Female Terminals
- Recommended Plug: Item # 34210, **Lifetime Warranty**

Item #	LEDs	Lens	Pack	Carton
39984B	7 Amber	Amber	1 Pc.	20/Carton
39985B	7 Red	Red	1 Pc.	20/Carton
39984BAK	7 Amber	Amber	1 Kit	20/Carton
39985BRK	7 Red	Red	1 Kit	20/Carton

**9 LED 2" Clearance/Marker Light - Flat**

DESCRIPTION

- 2" Flat LED Clearance/Marker Light with 9 LEDs
- Available in Colored or Clear Lens with 2 Female Terminals
- Recommended Plug: Item # 34210, **Lifetime Warranty**

Item #	LEDs	Lens	Pack	Carton
38170B	9 Amber	Amber	1 Pc.	20/Carton
38171B	9 Red	Red	1 Pc.	20/Carton
38170BAK	9 Amber	Amber	1 Kit	20/Carton
38171BRK	9 Red	Red	1 Kit	20/Carton

**9 LED 2" Clearance/Marker Light - Flat/Low Profile**

DESCRIPTION

- 2" Low Profile Flat LED Clearance/Marker Light with 9 LEDs
- Available in Colored or Clear Lens with 2 Female Terminals
- Recommended Plug: Item # 34210, **Lifetime Warranty**

Item #	LEDs	Lens	Pack	Carton
38409B	9 Amber	Amber	1 Pc.	20/Carton
38411B	9 Red	Red	1 Pc.	20/Carton
38409BAK	9 Amber	Amber	1 Kit	20/Carton
38411BRK	9 Red	Red	1 Kit	20/Carton

**4 LED 2" Clearance/Marker Light - Flat/Low Profile**

DESCRIPTION

- 2" Low Profile Flat LED Clearance/Marker Light with 4 LEDs
- Available in Colored or Clear Lens with 2 Female Terminals
- Recommended Plug: Item # 34210, **Lifetime Warranty**

Item #	LEDs	Lens	Pack	Carton
38457B	4 Amber	Amber	1 Pc.	20/Carton
38458B	4 Red	Red	1 Pc.	20/Carton
38457BAK	4 Amber	Amber	1 Kit	20/Carton
38458BRK	4 Red	Red	1 Kit	20/Carton



1 LED 2" Clearance/Marker Light - Flat/Low Profile

DESCRIPTION

- 1 LED 2" Economy Clearance/Marker Light
- Available in Colored or Clear Lens with 2 Female Terminals
- Recommended Plug: Item # 34210, **Lifetime Warranty**

Item #	LEDs	Lens	Pack	Carton
39910B	1 Amber	Amber	1 Pc.	20/Carton
39911B	1 Red	Red	1 Pc.	20/Carton
39910BAK	1 Amber	Amber	1 Kit	20/Carton
39911BRK	1 Red	Red	1 Kit	20/Carton

**9 LED 2" Clearance/Marker Light - Beehive**

DESCRIPTION

- 2" Beehive LED Clearance/Marker Light with 9 LEDs
- Available in Colored or Clear Lens with 2 Female Terminals
- Recommended Plug: Item # 34210, **Lifetime Warranty**

Item #	LEDs	Lens	Pack	Carton
38168B	9 Amber	Amber	1 Pc.	20/Carton
38169B	9 Red	Red	1 Pc.	20/Carton

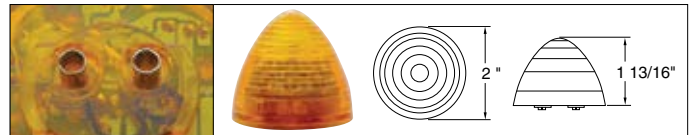
**9 LED 2 1/2" Clearance/Marker Light - GLO Light**

DESCRIPTION

- 9 LED 2 1/2" Clearance/Marker "GLO" Light
- Available in Colored or Clear Lens with 2 Female Terminals
- Recommended Plug: Item # 34210, **Lifetime Warranty**

Item #	LEDs	Lens	Pack	Carton
37016B	9 Amber	Amber	1 Pc.	20/Carton
37017B	9 Red	Red	1 Pc.	20/Carton
37016BAK	9 Amber	Amber	1 Kit	20/Carton
37017BRK	9 Red	Red	1 Kit	20/Carton



GloLight
Stand Out



9 LED 2 1/2" Clearance/Marker Light - Reflector

DESCRIPTION

- 9 LED 2 1/2" Clearance/Marker Light with Reflector
- Available with Amber or Red LED with Colored or Clear Lens
- Recommended Plug: Item # 34210, **Lifetime Warranty**

Item #	LEDs	Lens	Pack	Carton
39739B	9 Amber	Amber	1 Pc.	20/Carton
39740B	9 Red	Red	1 Pc.	20/Carton
39739BAK	9 Amber	Amber	1 Kit	20/Carton
39740BRK	9 Red	Red	1 Kit	20/Carton

**8 LED 2 1/2" Clearance / Marker Light - Reflectorized Lens**

DESCRIPTION

- 8 LED 2 1/2" Clearance / Marker Light with Reflectorized Lens
- Kit Includes 2 1/2" Lamp, Rubber Grommet (Item # 31503) and Plug (Item # 34210), **Lifetime Warranty**

Item #	LEDs	Lens	Pack	Carton
38455B	8 Amber	Amber	1 Pc.	20/Carton
38456B	8 Red	Red	1 Pc.	20/Carton
38455BAK	8 Amber	Amber	1 Kit	20/Carton
38456BRK	8 Red	Red	1 Kit	20/Carton

**13 LED 2 1/2" Clearance/Marker Light - Flat**

DESCRIPTION

- 2 1/2" Flat LED Clearance/Marker Light with 13 LEDs
- Available in Colored or Clear Lens with 2 Female Terminals
- Recommended Plug: Item # 34210, **Lifetime Warranty**

Item #	LEDs	Lens	Pack	Carton
38176B	13 Amber	Amber	1 Pc.	20/Carton
38177B	13 Red	Red	1 Pc.	20/Carton
38176BAK	13 Amber	Amber	1 Kit	20/Carton
38177BRK	13 Red	Red	1 Kit	20/Carton

**4 LED 2 1/2" Clearance/Marker Light - Flat/Low Profile**

DESCRIPTION

- 2 1/2" Low Profile Flat LED Clearance/Marker Light with 4 LEDs
- Available in Colored or Clear Lens with 2 Female Terminals
- Recommended Plug: Item # 34210, **Lifetime Warranty**

Item #	LEDs	Lens	Pack	Carton
38465B	4 Amber	Amber	1 Pc.	20/Carton
38466B	4 Red	Red	1 Pc.	20/Carton
38465BAK	4 Amber	Amber	1 Kit	20/Carton
38466BRK	4 Red	Red	1 Kit	20/Carton



13 LED "Phantom I" Marker Light - GLO Light

DESCRIPTION

- 13 LED "Phantom I" Clearance/Marker Light with Chrome Plastic Bezel
- Hard Wired with 2 Wires, Unique Patent Pending "GLO" Design
Lifetime Warranty

Item #	LEDs	Lens	Pack	Carton
36988B	13 Amber	Amber	1 Pc.	20/Carton
36989B	13 Red	Red	1 Pc.	20/Carton

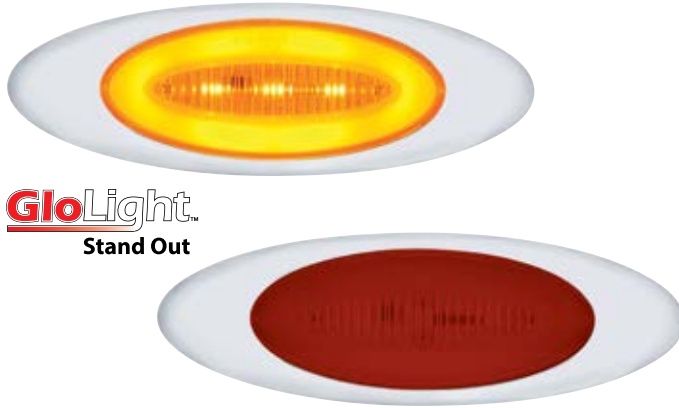

6 LED "Phantom II" Marker Light - GLO Light

DESCRIPTION

- 6 LED "Phantom II" Clearance/Marker Light with Chrome Plastic Bezel
- Hard Wired with 2 Wires, Unique Patent Pending "GLO" Design
Lifetime Warranty

Item #	LEDs	Lens	Pack	Carton
36984B	6 Amber	Amber	1 Pc.	20/Carton
36985B	6 Red	Red	1 Pc.	20/Carton



5 LED M3 Clearance/Marker Light - GLO Light

DESCRIPTION

- 5 LED M3 Clearance/Marker Light with Chrome Plastic Bezel
- Unique Patent Pending "GLO" Design
- Hard Wired with 2 Wires, **Lifetime Warranty**

Item #	LEDs	Lens	Pack	Carton
36968B	5 Amber	Amber	1 Pc.	20/Carton
36969B	5 Red	Red	1 Pc.	20/Carton



16 LED Rectangular Clearance/Marker Light - GLO Light

DESCRIPTION

- 16 LED Rectangular Clearance/Marker "GLO" Light with Chrome Plastic Bezel
- Available in Amber or Red LED with Colored Lens, Hard Wired
- Hard Wired with 2 Wires, **Lifetime Warranty**

Item #	LEDs	Lens	Pack	Carton
36980B	16 Amber	Amber	1 Pc.	20/Carton
36981B	16 Red	Red	1 Pc.	20/Carton

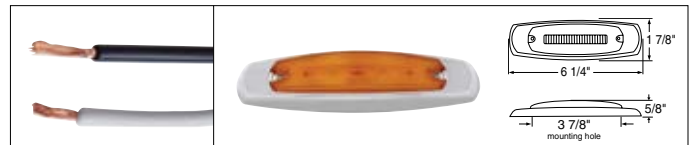

16 LED Rectangular Clearance/Marker Light - GLO Light

DESCRIPTION

- 16 LED Large Rectangular Clearance/Marker "GLO" Light
- Unique Patent Pending "GLO" Design
- Hard Wired with 2 Wires, **Lifetime Warranty**

Item #	LEDs	Lens	Pack	Carton
36976B	16 Amber	Amber	1 Pc.	20/Carton
36977B	16 Red	Red	1 Pc.	20/Carton

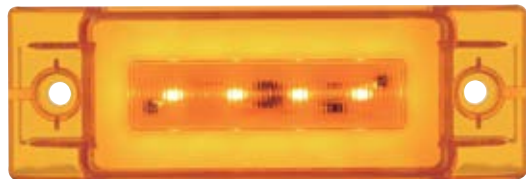

GloLight™
Stand Out

**10 LED Rectangular Clearance/Marker Light - GLO Light**

DESCRIPTION

- 10 LED Rectangular Clearance/Marker "GLO" Light
- Available in Colored or Clear Lens
- Recommended Plug: Item # 30919/33006, **Lifetime Warranty**

Item #	LEDs	Lens	Pack	Carton
36992B	10 Amber	Amber	1 Pc.	20/Carton
36993B	10 Red	Red	1 Pc.	20/Carton

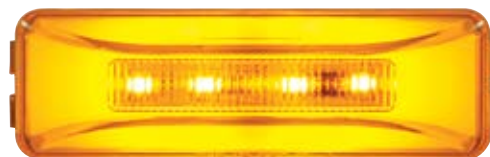

GloLight™
Stand Out

**8 LED Rectangular Clearance/Marker Light - GLO Light**

DESCRIPTION

- 8 LED Small Rectangular Clearance/Marker Light with Chrome Plastic Bezel
- Unique Patent Pending "GLO" Design
- Hard Wired with 2 Wires, **Lifetime Warranty**

Item #	LEDs	Lens	Pack	Carton
36972B	8 Amber	Amber	1 Pc.	20/Carton
36973B	8 Red	Red	1 Pc.	20/Carton



GloLight™
Stand Out

**4 LED Rectangular Clearance/Marker Light - Reflector**

DESCRIPTION

- 4 LED Reflector Clearance/Marker Light with Chrome Plastic Bezel
- Available with 4 Amber LEDs or 4 Red LEDs, Hard Wired
- Recommended Plug: Item # 34203/34250, **Lifetime Warranty**

Item #	LEDs	Lens	Pack	Carton
39398B	4 Amber	Amber	1 Pc.	20/Carton
39399B	4 Red	Red	1 Pc.	20/Carton



8 LED Rectangular Clearance/Marker Light

DESCRIPTION

- 8 LED Rectangular Clearance/Marker Light
- Reflex Lens, Hard Wired with 2 Bullet Plugs
- Recommended Plug: Item # 34203/34250, **Lifetime Warranty**

Item #	LEDs	Lens	Pack	Carton
38258B	8 Amber	Amber	1 Pc.	20/Carton
38259B	8 Red	Red	1 Pc.	20/Carton

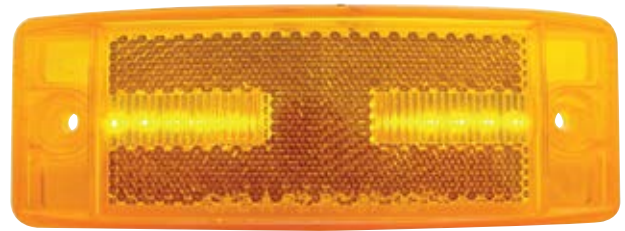

16 LED Rectangular Clearance/Marker Light - 2 Wires

DESCRIPTION

- 16 LED Rectangular Clearance/Marker Light
- Hard Wired with Two .180 Bullet Plugs
- Recommended Plug: Item # 34203/34250, **Lifetime Warranty**

Item #	LEDs	Lens	Pack	Carton
38225B	16 Amber	Amber	1 Pc.	20/Carton
38226B	16 Red	Red	1 Pc.	20/Carton



16 LED Rectangular Clearance/Marker Light - 1 Wire

DESCRIPTION

- 16 LED Rectangular Clearance/Marker Light
- Hard Wired with One .180 Bullet Plug (Self Grounding)
- Recommended Plug: Item # 34250, **Lifetime Warranty**

Item #	LEDs	Lens	Pack	Carton
38191B	16 Amber	Amber	1 Pc.	20/Carton
38192B	16 Red	Red	1 Pc.	20/Carton





14 LED Rectangular Clearance/Marker Light

DESCRIPTION

- 14 LED Rectangular Clearance/Marker Light
- Available in Colored or Clear Lens, Hard Wired with Two .180 Bullet Plugs
- Recommended Plug: Item # 34203/34250, **Lifetime Warranty**

Item #	LEDs	Lens	Pack	Carton
39904B	14 Amber	Amber	1 Pc.	20/Carton
39905B	14 Red	Red	1 Pc.	20/Carton



6 LED Fender Mount Clearance / Marker Light

DESCRIPTION

- 6 LED Fender Mount Clearance / Marker Light
- Dual Color Lens with 3 Amber and 3 Red LEDs
- Kit Includes LED Light and Mounting Bracket (Item # 33006), **Lifetime Warranty**

Item #	LEDs	Lens	Pack	Carton
36774B	6	Amber / Red	1 Pc.	20/Carton
36774BARK-B	6	Amber / Red	1 Kit	20/Carton

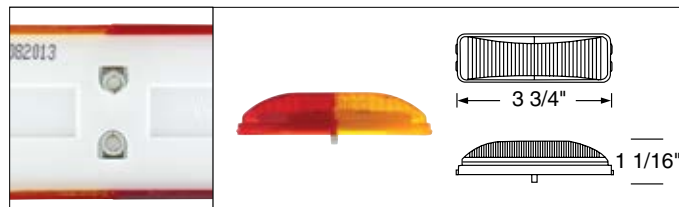

6 LED Clearance/Marker Light

DESCRIPTION

- 6 LED Clearance/Marker Light
- Hard Wired (1 Wire with .180 Bullet Plug and 1 Wire with Ring Terminal)
- Recommended Plug: Item # 34250, **Lifetime Warranty**

Item #	LEDs	Lens	Pack	Carton
38165B	6 Amber	Amber	1 Pc.	20/Carton
38166B	6 Red	Red	1 Pc.	20/Carton

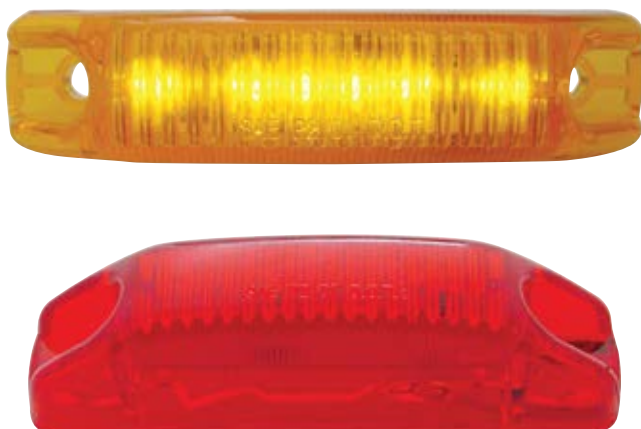

12 LED Rectangular Clearance/Marker Light

DESCRIPTION

- 12 LED Rectangular Clearance/Marker Light
- Available with 12 Amber LEDs or 12 Red LEDs with Colored or Clear Lens
- Mounting Base: Item # 30919/33006, **Lifetime Warranty**

Item #	LEDs	Lens	Pack	Carton
38161B	12 Amber	Amber	1 Pc.	20/Carton
38162B	12 Red	Red	1 Pc.	20/Carton
38161BAK-B	12 Amber	Amber	1 Kit	20/Carton
38162BAK-B	12 Red	Red	1 Kit	20/Carton

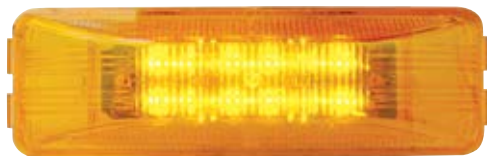
**1 LED Rectangular Clearance/Marker Light**

DESCRIPTION

- 1 LED Rectangular Economy Clearance/Marker Light
- Available in Colored or Clear Lens
- Recommended Plug: Item # 30919/33006, **Lifetime Warranty**

Item #	LEDs	Lens	Pack	Carton
39918B	1 Amber	Amber	1 Pc.	20/Carton
39919B	1 Red	Red	1 Pc.	20/Carton
39918BAK-B	1 Amber	Amber	1 Kit	20/Carton
39919BRK-B	1 Red	Red	1 Kit	20/Carton

**6 LED Clearance/Marker Light**

DESCRIPTION

- 6 LED Small Rectangular Clearance/Marker Light
- Available with 6 Amber LEDs or 6 Red LEDs
- Mounting Base: Item # 33002/33002P/33003, **Lifetime Warranty**

Item #	LEDs	Lens	Pack	Carton
38158B	6 Amber	Amber	1 Pc.	20/Carton
38159B	6 Red	Red	1 Pc.	20/Carton
38158BAK-B	6 Amber	Amber	1 Kit	20/Carton
38159BRK-B	6 Red	Red	1 Kit	20/Carton

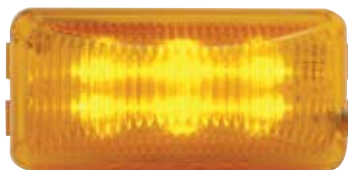
**3 LED Mini Clearance/Marker Light**

DESCRIPTION

- 3 LED Mini Clearance/Marker Light
- Requires a 13/16" Opening, Grommet Mount, 7 1/2" Wire Lead
- Available in Amber, Blue, Red or White LED with Colored or Clear Lens
- Stainless Bezel Available Separately: UP Item # 20527B, **Lifetime Warranty**

Item #	LEDs	Lens	Pack	Carton
39767B	3 Amber	Amber	1 Pc.	20/Carton
39768B	3 Red	Red	1 Pc.	20/Carton
39772B	3 White	Clear	1 Pc.	20/Carton





LED STOP, TURN, & TAIL AND PARKING, TURN, & CLEARANCE LIGHTS

21 LED 4" S/T/T & P/T/C Light - GLO Light

DESCRIPTION

- 21 LED 4" Round S/T/T & P/T/C "GLO" Light
- Unique Patent Pending "GLO" Design
- Available in Colored or Clear Lens, 3 Contact Female Terminal
- Recommended Plug: Item # 34212/34216, **Lifetime Warranty**

Item #	LEDs	Lens	Pack	Carton
37133B	21 Amber	Amber	1 Pc.	20/Carton
37132B	21 Red	Red	1 Pc.	20/Carton
37133BAK	21 Amber	Amber	1 Kit	20/Carton
37132BRK	21 Red	Red	1 Kit	20/Carton

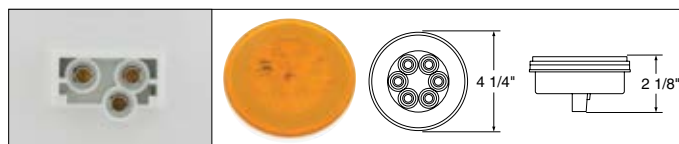

18 LED 4" Round - GLO Light

DESCRIPTION

- 18 LED 4" S/T/T & P/T/C "GLO" Light
- Unique Patented "GLO" Design, Halo Effect on Running, All LEDs Lit on Stop
- 3 Contact Female Terminal
- Recommended Plug: Item # 34212/34216, **Lifetime Warranty**

Item #	LEDs	Lens	Pack	Carton
36923B	18 Amber	Amber	1 Pc.	20/Carton
36922B	18 Red	Red	1 Pc.	20/Carton
36923BAK	18 Amber	Amber	1 Kit	20/Carton
36922BRK	18 Red	Red	1 Kit	20/Carton

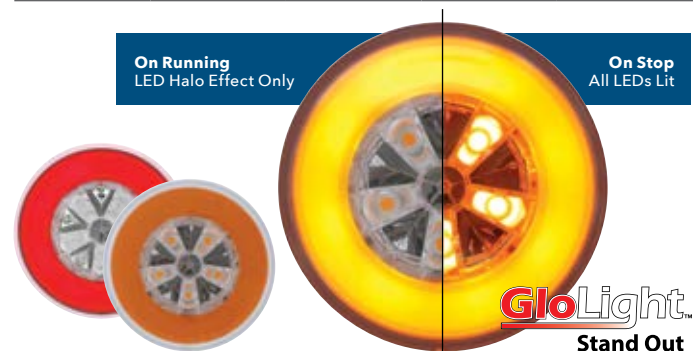

7 LED 4" S/T/T - Competition Series Light

DESCRIPTION

- 7 LED 4" "Competition Series" S/T/T Light
- Recommended Plug: Item # 34212/34216, **Lifetime Warranty**

Item #	LEDs	Lens	Pack	Carton
39119B	7 Amber	Amber	1 Pc.	20/Carton
39117B	7 Red	Red	1 Pc.	20/Carton
39119BAK	7 Amber	Amber	1 Kit	20/Carton
39117BRK	7 Red	Red	1 Kit	20/Carton



COMPETITION
SERIES



21 LED 4" S/T/T Light - Competition Series

DESCRIPTION

- 21 LED 4" Round Competition Series S/T/T Light
- Available in Red or Clear Lens, 3 Contact Female Terminal
- Recommended Plug: Item # 34212/34216, **Lifetime Warranty**

Item #	LEDs	Lens	Pack	Carton
39821B	21 Red	Red	1 Pc.	20/Carton
39821BRK	21 Red	Red	1 Kit	20/Carton



COMPETITION
SERIES



30 LED 4" S/T/T Light

DESCRIPTION

- 30 LED 4" Round S/T/T Light
- Available in Red or Clear Lens, 3 Contact Female Terminal
- Recommended Plug: Item # 34212/34216, **Lifetime Warranty**

Item #	LEDs	Lens	Pack	Carton
39440B	30 Red	Red	1 Pc.	20/Carton
39440BRK	30 Red	Red	1 Kit	20/Carton



16 LED 4" P/T/C Light - Reflector

DESCRIPTION

- 16 LED 4" Round P/T/C Light with Chrome Reflector
- Available in Amber Lens Only, 3 Contact Female Terminal
- Recommended Plug: Item # 34212/34216, **Lifetime Warranty**

Item #	LEDs	Lens	Pack	Carton
39343B	16 Amber	Amber	1 Pc.	20/Carton
39343BAK	16 Amber	Amber	1 Kit	20/Carton

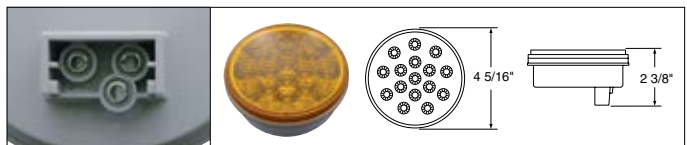

12 LED 4" S/T/T Light - Reflector

DESCRIPTION

- 12 LED 4" Round S/T/T Light with Chrome Reflector
- Available in Red or Clear Lens, 3 Contact Female Terminal
- Recommended Plug: Item # 34212/34216, **Lifetime Warranty**

Item #	LEDs	Lens	Pack	Carton
38116B	12 Red	Red	1 Pc.	20/Carton
38116BRK	12 Red	Red	1 Kit	20/Carton

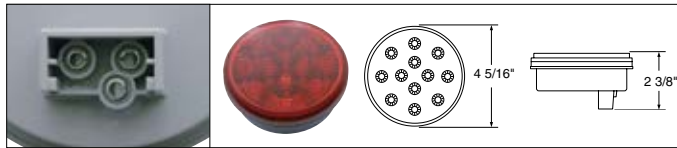
**10 LED 4" S/T/T & P/T/C Light**

DESCRIPTION

- 10 LED 4" Round S/T/T or P/T/C Light
- Available in Colored or Clear Lens, Hard Wired with 3 Contact Female Plug
- Recommended Plug: Item # 34212, **Lifetime Warranty**

Item #	LEDs	Lens	Pack	Carton
38771B	10 Amber	Amber	1 Pc.	20/Carton
38770B	10 Red	Red	1 Pc.	20/Carton
38771BAK	10 Amber	Amber	1 Kit	20/Carton
38770BRK	10 Red	Red	1 Kit	20/Carton

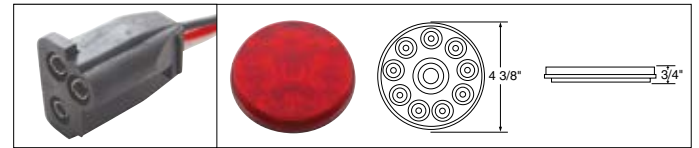
**7 LED 4" S/T/T & P/T/C Light - Reflector**

DESCRIPTION

- 7 LED 4" Round S/T/T & P/T/C Light with Chrome Reflector
- Available in Colored or Clear Lens, 3 Contact Female Terminal
- Recommended Plug: Item # 34212/34216, **Lifetime Warranty**

Item #	LEDs	Lens	Pack	Carton
39973B	7 Amber	Amber	1 Pc.	20/Carton
39924B	7 Red	Red	1 Pc.	20/Carton
39973BAK	7 Amber	Amber	1 Kit	20/Carton
39924BRK	7 Red	Red	1 Kit	20/Carton

**21 LED 4" S/T/T & P/T/C Flanged - GLO Light**

DESCRIPTION

- 21 LED 4" S/T/T & P/T/C "GLO" Light
- Unique Patented "GLO" Design, Halo Effect on Running, All LEDs Lit on Stop
- 3 Contact Female Terminal, Available in Color or Clear Lens
- Recommended Plug: Item # 34212/34216, **Lifetime Warranty**

Item #	LEDs	Lens	Pack	Carton
36958B	21 Amber	Amber	1 Pc.	20/Carton
36957B	21 Red	Red	1 Pc.	20/Carton

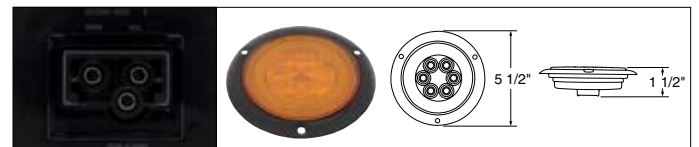

12 LED 4" S/T/T Light - Bubble Lens/Deep Dish

DESCRIPTION

- 12 LED 4" Round S/T/T Light, Flange Mount
- Stainless Steel Deep Dish Housing with Bubble Lens, Hard Wired with 3 Contact Female Plug
- Recommended Plug: Item # 34212, **Lifetime Warranty**

Item #	LEDs	Lens	Pack	Carton
38061B	12 Red	Red	1 Pc.	20/Carton

**10 LED 4" S/T/T Light - Reflex Flange**

DESCRIPTION

- 10 LED 4" Round S/T/T Light, Flange Mount
- Flange Mount, Hard Wired with 3 Contact Female Plug
- Recommended Plug: Item # 34212, **Lifetime Warranty**

Item #	LEDs	Lens	Pack	Carton
39656B	10 Red	Red	1 Pc.	20/Carton

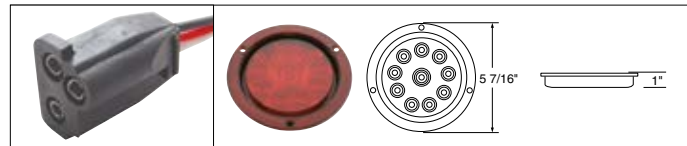
**7 LED 6" Oval S/T/T Light**

DESCRIPTION

- 6" Oval S/T/T Light with 7 Red LED
- Available in Red or Clear Lens, 3 Contact Female Terminal
- Recommended Plug: Item # 34212/34216, **Lifetime Warranty**

Item #	LEDs	Lens	Pack	Carton
36855B	7 Red	Red	1 Pc.	20/Carton
36855BRK	7 Red	Red	1 Kit	20/Carton

**10 LED Oval S/T/T & P/T/C Light**

DESCRIPTION

- 10 LED 6" Oval S/T/T or P/T/C Light
- Available in Colored or Clear Lens, Hard Wired with 3 Contact Female Plug
- Recommended Plug: Item # 34212, **Lifetime Warranty**

Item #	LEDs	Lens	Pack	Carton
36771B	10 Red	Red	1 Pc.	20/Carton
36771BRK	10 Red	Red	1 Kit	20/Carton



GloLight[™]

Stand Out



22 LED 6" Oval - GLO Light

DESCRIPTION

- 22 LED 6" S/T/T & P/T/C "GLO" Light
- Unique Patented "GLO" Design, Halo Effect on Running, All LEDs Lit on Stop
- 3 Contact Female Terminal
- Recommended Plug: Item # 34212/34216, **Lifetime Warranty**

Item #	LEDs	Lens	Pack	Carton
36925B	22 Amber	Amber	1 Pc.	20/Carton
36924B	22 Red	Red	1 Pc.	20/Carton
36925BAK	22 Amber	Amber	1 Kit	20/Carton
36924BRK	22 Red	Red	1 Kit	20/Carton



GloLight[™]

Stand Out



22 LED 6" Oval S/T/T & P/T/C Light - GLO Light

DESCRIPTION

- 22 LED 6" Oval S/T/T & P/T/C "GLO" Light
- Unique Patent Pending "GLO" Design
- Available in Colored or Clear Lens, 3 Contact Female Terminal
- Recommended Plug: Item # 34212/34216, **Lifetime Warranty**

Item #	LEDs	Lens	Pack	Carton
37129B	22 Amber	Amber	1 Pc.	20/Carton
37128B	22 Red	Red	1 Pc.	20/Carton
37129BAK	22 Amber	Amber	1 Kit	20/Carton
37128BRK	22 Red	Red	1 Kit	20/Carton



12 LED Oval S/T/T Light - Reflector

DESCRIPTION

- 12 LED Oval S/T/T Light with Chrome Reflector
- Available in Red or Clear Lens, 3 Contact Female Terminal
- Recommended Plug: Item # 34212/34216, **Lifetime Warranty**

Item #	LEDs	Lens	Pack	Carton
38121B	12 Red	Red	1 Pc.	20/Carton
38121BRK	12 Red	Red	1 Kit	20/Carton



10 LED Oval S/T/T & P/T/C Light - Chrome Bezel

DESCRIPTION

- 10 LED 6" Oval S/T/T or P/T/C Light with Chrome Bezel
- Available in Colored or Clear Lens, Hard Wired with 3 Contact Female Plug
- Universal Flange Mount, Mount onto Any Flat Surface
- Recommended Plug: Item # 34212, **Lifetime Warranty**

Item #	LEDs	Lens	Pack	Carton
38901B	10 Amber	Amber	1 Pc.	20/Carton
38900B	10 Red	Red	1 Pc.	20/Carton



18 LED Mid-Trailer Turn Signal Light

DESCRIPTION

- 18 LED 6" Mid-Trailer Turn Signal Light
- Available in Amber or Clear Lens, 3 Contact Female Terminal
- Recommended Plug: Item # 34212/34216, **Lifetime Warranty**

Item #	LEDs	Lens	Pack	Carton
38920B	18 Amber	Amber	1 Pc.	20/Carton
38920BAK	18 Amber	Amber	1 Kit	20/Carton



14 LED Rectangular P/T/C Light - GLO Light

DESCRIPTION

- 14 LED Rectangular P/T/C "GLO" Light
- Available in Colored or Clear Lens, 3 Contact Terminal
- Recommended Plug: Item # 34212/34216, **Lifetime Warranty**

Item #	LEDs	Lens	Pack	Carton
36961B	14 Amber	Amber	1 Pc.	20/Carton
36962B	14 Red	Red	1 Pc.	20/Carton
36961BAK	14 Amber	Amber	1 Kit	20/Carton
36962BRK	14 Red	Red	1 Kit	20/Carton

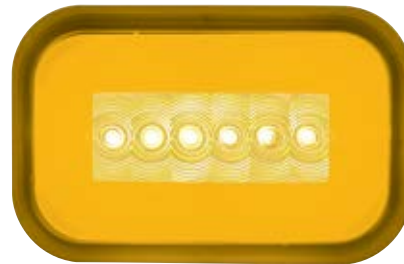

GloLight.
Stand Out



15 LED Rectangular S/T/T & P/T/C Light

DESCRIPTION

- 15 LED Rectangular S/T/T & P/T/C Light, Unique Lens Design
- Available in Colored or Clear Lens, 3 Contact Terminal
- Recommended Plug: Item # 34212/34216, **Lifetime Warranty**

Item #	LEDs	Lens	Pack	Carton
38746B	15 Amber	Amber	1 Pc.	20/Carton
38747B	15 Red	Red	1 Pc.	20/Carton
38746BAK	15 Amber	Amber	1 Kit	20/Carton
38747BRK	15 Red	Red	1 Kit	20/Carton



LED Universal Combination Light - Reflector

DESCRIPTION

- Functions as S/T/T, Back-Up, and License Light
- 16 Red LED (S/T/T) + 2 Red LED (Clearance/Marker) + 22 White LED (Back Up) + 4 White LED (License)
- Please Specify with or without License Light
- 3 Bolt Mount on 2" Triangle Pattern, **Lifetime Warranty**

Item #	LEDs	License Light	Pack	Carton
39353B	16 Red, 22 White	No	1 Pc.	20/Carton
39354B	16 Red, 22+4 White	Yes	1 Pc.	20/Carton

Item # 39354B
Combination Light with
License Light



Item # 39354B
Combination Light with
Side Marker Light



LED Universal Combination Light w/Side Marker Light

DESCRIPTION

- Functions as S/T/T, Clearance/Marker, Back-Up, and License Light
- 16 Red LED (S/T/T) + 2 Red LED (Clearance/Marker) + 22 White LED (Back-Up) + 4 White LED (License)
- Please Specify with or without License Light
- 3 Bolt Mount on 2" Triangle Pattern, **Lifetime Warranty**

Item #	LEDs	License Light	Pack	Carton
38490B	16+2 Red, 22 White	No	1 Pc.	20/Carton
38491B	16+2 Red, 22+4 White	Yes	1 Pc.	20/Carton

Item # 38491B
Combination Light with
License Light



Item # 38491B
Combination Light with
Side Marker Light



LED Submersible Combination Light - Reflector

DESCRIPTION

- Submersible Combination Light with 12 Red LEDs + 3 Red LEDs (Side Marker) + 5 White LEDs (License Illuminator)
- Rear Clearance Light for Over 80" Wide Application
- 3 Wires (White = Ground, Green = Stop/Turn, Brown = Tail/Marker/License), **Lifetime Warranty**

Item #	LEDs	License Light	Pack	Carton
39551B	18 + 3 Red	No	1 Pc.	20/Carton
39552B	18 + 3 Red, 5 White	Yes	1 Pc.	20/Carton



LED Submersible Combination Light

DESCRIPTION

- Submersible Combination Light with 12 Red LEDs + 4 Red LEDs (Side Marker) + 4 White LEDs (License Illuminator)
- Rear Clearance Light for Over 80" Wide Application
- 3 Wires (White = Ground, Green = Stop/Turn, Brown = Tail/Marker/License), **Lifetime Warranty**

Item #	LEDs	License Light	Pack	Carton
38310B	12+4 Red	No	1 Pc.	20/Carton
38311B	12+4 Red, 4 White	Yes	1 Pc.	20/Carton



12 LED Submersible Combination Light - Reflector

DESCRIPTION

- 12 LED Over 80" Submersible Combination Light w/ Reflector
- Designed with Acrylic Lens and Impact Resistant Housing
- Available with or without License Illuminator
- 3 Wires (White = Ground, Green = Stop/Turn, Brown = Tail/Marker/License), **Lifetime Warranty**

Item #	LEDs	License Light	Pack	Carton
39455B	12 Red	No	1 Pc.	20/Carton
39456B	12 Red, 4 White	Yes	1 Pc.	20/Carton



32 LED 7" S/T/T & P/T/C Light - GLO Light

DESCRIPTION

- 32 LED 7" Round S/T/T & P/T/C "GLO" Light
- Available in Amber or Red Lens, Perfect for Bus Application
- 3 Wires (1 Wire with Ring Terminal), **Lifetime Warranty**

Item #	LEDs	Lens	Pack	Carton
37033B	32 Amber	Amber	1 Pc.	20/Carton
37034B	32 Red	Red	1 Pc.	20/Carton

GloLight
Stand Out

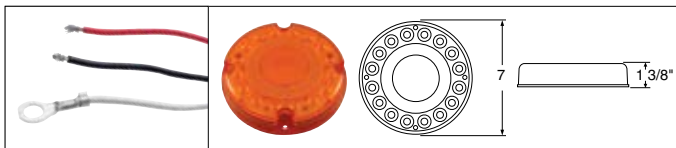
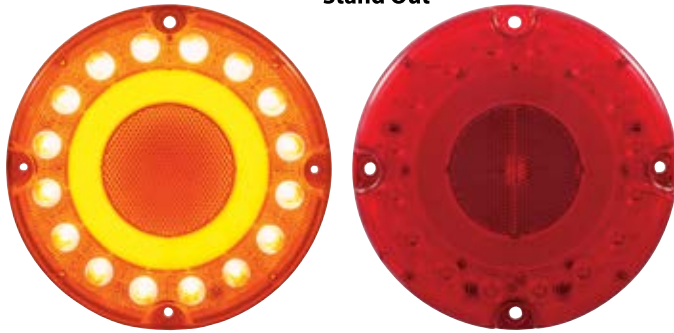
**17 LED 7" S/T/T & P/T/C Light**

DESCRIPTION

- 17 LED 7" Round S/T/T & P/T/C Light
- Available in Amber or Red Lens, Perfect for Bus Application
- 3 Wires (1 Wire with Ring Terminal), **Lifetime Warranty**

Item #	LEDs	Lens	Pack	Carton
39960B	17 Amber	Amber	1 Pc.	20/Carton
39961B	17 Red	Red	1 Pc.	20/Carton

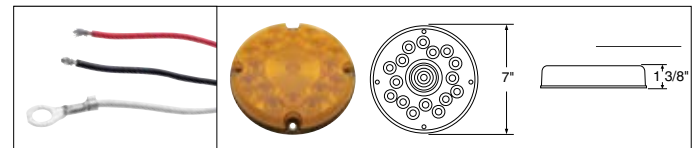
**19 LED S/T/T Light - STUD Mount**

DESCRIPTION

- 19 LED 4" Stud Mount S/T/T Light
- Stud Mount, Black Housing, Studs are Approximately 2" Apart
- Available with or without License Illuminator
- Ground Through Mounting Hardware, **Lifetime Warranty**

Item #	LEDs	License Light	Pack	Carton
38473B	19 Red	No	1 Pc.	20/Carton
38474B	19 Red, 5 White	Yes	1 Pc.	20/Carton

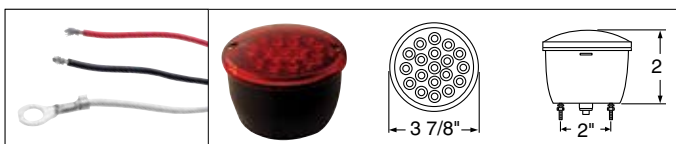
**35 LED Economy Oval Sequential Auxiliary Signal Light**

DESCRIPTION

- 35 LED Economy Sequential Oval Auxiliary Signal Light
- Electronics Completely Sealed in Epoxy to Resist Corrosion and Moisture
- Recommended Plug: Item # 34212/34216, **Lifetime Warranty**

Item #	LEDs	Lens	Pack	Carton
38143B	35 Amber	Amber	1 Pc.	20/Carton
38143BAK	35 Amber	Amber	1 Kit	20/Carton

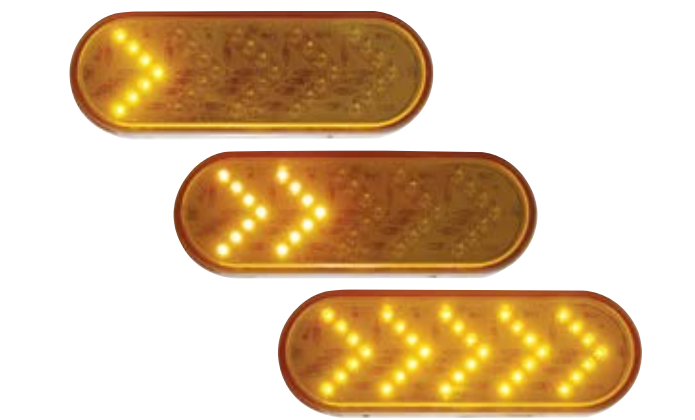



LED LIGHT BAR

49" High Power LED Warning Light Bar

DESCRIPTION

- 49" High Power LED Warning Light Bar, 12V - 24V Application, 26 Flash Pattern
- 3 LED Fresnel Optics for Front / Rear Lighthoods and 6 LED Large D-Fuser for Corner Lighthoods
- SAE J845, Class 13, IPX 4 Rated
- Available with 8 (4 Inboards) Lighthoods, 12 (8 Inboards) Lighthoods, or 16 (12 Inboards) Lighthoods
- Brackets Required for Installation, Includes Standard Bolt / Strap Mount Bracket

Item #	Length	LEDs	LED Heads	Pack
36668	49"	36	8	1 Pc./Box
36669	49"	48	12	1 Pc./Box
36670	49"	60	1 Pc./Box	

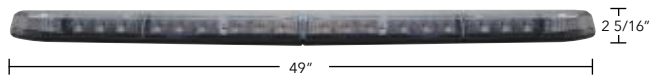

Standard Bolt / Strap Mount

**SAE J845
Class 13**

**IPX 4
Rated**



36668 - 8 LED Lighthoods



36669 - 12 LED Lighthoods



36670 - 16 LED Lighthoods



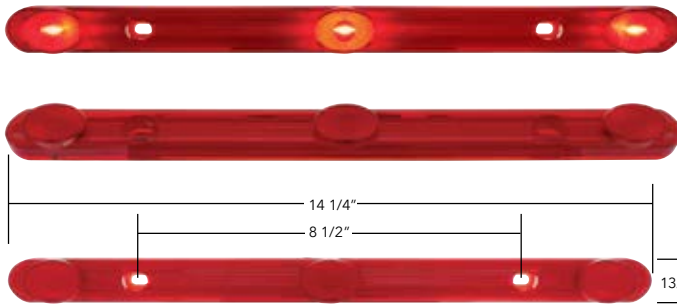

3 LED 14 1/4" ID Light Bar

DESCRIPTION

- 3 LED 14 1/4" ID Light Bar
- 2 Wire Hardwired
- Mounting Holes are 8 1/2" Apart, **Lifetime Warranty**

Item #	LEDs	Lens	Pack	Carton
38479B	3 Red	Red	1 Pc.	20/Carton



Item #	LEDs	Lens	Pack	Carton
37079B	28 Amber	Amber	1 Pc.	20/Carton
37080B	28 Red	Red	1 Pc.	20/Carton

28 LED 17" Light Bar - GLO Light

DESCRIPTION

- 28 LED 17" "GLO" Light Bar
- Unique Patent Pending "GLO" Design, Halo Effect on Running, All LEDs Lit on Stop
- 3 Contact Female Terminal, Recommended Plug: Item # 34212/34216, **Lifetime Warranty**



GloLight™
Stand Out

Item #	LEDs	Lens	Pack	Carton
37089B	23 Amber	Amber	1 Pc.	20/Carton
37090B	23 Red	Red	1 Pc.	20/Carton

23 SMD LED 17 1/4" S/T/T & P/T/C Light Bar with Reflector

DESCRIPTION

- 23 SMD LED 17 1/4" S/T/T & P/T/C Light Bar with Reflector
- Available in Red Lens, Approximate Size: 17 1/4" L x 1" W
- Mounting Holes Approximately 16 1/8" Apart, **Lifetime Warranty**



Item #	LEDs	Lens	Pack	Carton
39990B	11 Amber	Clear	1 Pc.	20/Carton

11 LED 15" Light Bar

DESCRIPTION

- 11 LED 15" S/T/T & P/T/C Light Bar, Ultra Thin/Low Profile Design
- Available with Colored or Clear Lens, Approximate Size: 15" L x 1 3/8" W
- Mounting Holes Approximate 14 1/8" Apart, **Lifetime Warranty**

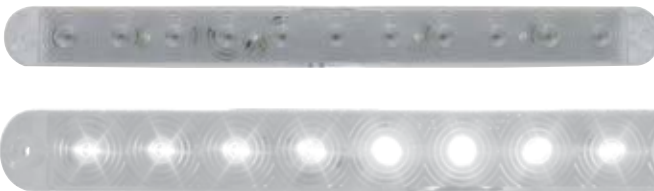

11 LED 17" Light Bar

DESCRIPTION

- 11 LED S/T/T & P/T/C Light Bar, 17" L x 1 3/8" W x 1" H
- Available in Colored or Clear Lens, Mounting Holes Approximately 16 1/8" Apart

Item #	LEDs	Function	Lens	Pack	Carton
38463B	11 Amber	P/T/C	Amber	1 Pc.	20/Carton
38469B	11 Red	S/T/T	Red	1 Pc.	20/Carton

11 LED Stop, Turn & Tail
(Item # 38463, 38464, 38469, 38470)
• 3 Wires: - White Wire = Ground
- Black Wire = Tail
- Red Wire = Stop

11 LED Clearance, Sidemarker & Identification
(Item # 38471B & 38472B)
• 4 Wires: - White Wire = Ground
- Brown Wire = Clearance/Identification (All LED Lit)
- Green Wire = Right Turn Signal
- Yellow Wire = Left Turn Signal





LED BACK-UP AND LICENSE LIGHTS

21 LED 4" Back-Up Light - GLO Light

DESCRIPTION

- 4" Back-Up "GLO" Light with 21 Super White LED
- Epoxy Sealed, Specially Designed Lens, 3 Contact Female Terminal
- Recommended Plug: Item # 34212/34216, **Lifetime Warranty**

Item #	LEDs	Lens	Pack	Carton
37008B	21 White	Clear	1 Pc.	20/Carton
37008BCK	21 White	Clear	1 Kit	20/Carton

On Running
LED Halo Effect Only

On Stop
All LEDs Lit



GloLight.
Stand Out



20 LED 4" Back-Up - Competition Series Light

DESCRIPTION

- 4" Back-Up Light with 20 Super White LED
- Epoxy Sealed, Specially Designed Lens, 3 Contact Female Terminal
- Recommended Plug: Item # 34212/34216, **Lifetime Warranty**

Item #	LEDs	Lens	Pack	Carton
36680B	20 White	Clear	1 Pc.	20/Carton
36680BCK	20 White	Clear	1 Kit	20/Carton



COMPETITION
SERIES

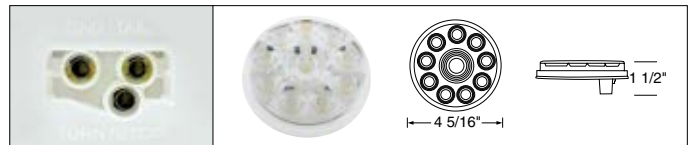

6 LED 4" Back-Up Light

DESCRIPTION

- 4" Round Back-Up Light with 6 Super White LED
- Epoxy Sealed, Specially Designed Lens, 3 Contact Female Terminal
- Recommended Plug: Item # 34212/34216, **Lifetime Warranty**

Item #	LEDs	Lens	Pack	Carton
38660B	6 White	Clear	1 Pc.	20/Carton
38660BCK	6 White	Clear	1 Kit	20/Carton

**20 LED 6" Oval Back-Up Light - Competition Series**

DESCRIPTION

- 6" Oval Back-Up Light with 20 Super White LED
- Epoxy Sealed, Specially Designed Lens, 3 Contact Female Terminal
- Recommended Plug: Item # 34212/34216, **Lifetime Warranty**

Item #	LEDs	Lens	Pack	Carton
36679B	20 White	Clear	1 Pc.	20/Carton
36679BCK	20 White	Clear	1 Kit	20/Carton

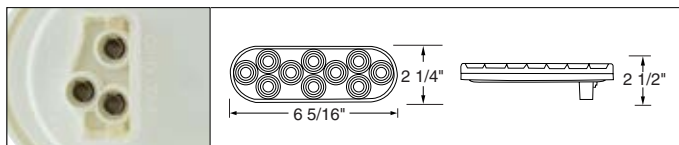

COMPETITION
SERIES

**22 LED 6" Oval Back-Up Light - GLO Light**

DESCRIPTION

- 6" Oval "GLO" Back-Up Light with 22 Super White LED
- Epoxy Sealed, Specially Designed Lens, 3 Contact Female Terminal
- Recommended Plug: Item # 34212/34216, **Lifetime Warranty**

Item #	LEDs	Lens	Pack	Carton
37009B	22 White	Clear	1 Pc.	20/Carton
37009BCK	22 White	Clear	1 Kit	20/Carton

**28 LED Oval Back-Up Light**

DESCRIPTION

- 28 Super Bright LED Oval Back-Up Light
- Specially Designed Lens, 3 Pin Male Terminal
- Recommended Plug: Item # 34236/34238, **Lifetime Warranty**

Item #	LEDs	Lens	Pack	Carton
38551B	28 White	Clear	1 Pc.	20/Carton
38551BCK	28 White	Clear	1 Kit	20/Carton



6 LED Oval Back-Up Light

DESCRIPTION

- 6 Super Bright LED Oval Back-Up Light
- Epoxy Sealed, Specially Designed Lens, 3 Contact Female Terminal
- Recommended Plug: Item # 34212/34216, **Lifetime Warranty**

Item #	LEDs	Lens	Pack	Carton
38661B	6 White	Clear	1 Pc.	20/Carton
38661BCK	6 White	Clear	1 Kit	20/Carton

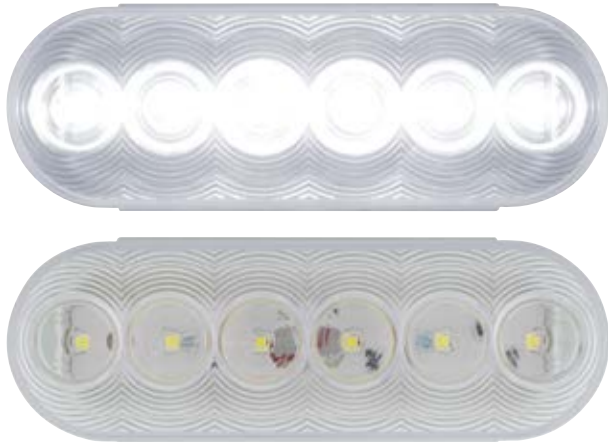
**32 LED Rectangular Back-Up Light**

DESCRIPTION

- 32 Super Bright White LED Back-Up Light
- Epoxy Sealed, Specially Designed Lens, 3 Contact Female Terminal
- Recommended Plug: Item # 34212/34216, **Lifetime Warranty**

Item #	LEDs	Lens	Pack	Carton
39998B	32 White	Clear	1 Pc.	20/Carton
39998BCK	32 White	Clear	1 Kit	20/Carton

**15 LED Rectangular Auxiliary/Utility Light**

DESCRIPTION

- 15 Super Bright White LED Rectangular Auxiliary/Utility Light
- Epoxy Sealed, Specially Designed Lens, 3 Contact Female Terminal
- Recommended Plug: Item # 34212/34216, **Lifetime Warranty**

Item #	LEDs	License Light	Pack	Carton
38778B	15 White	Clear	1 Pc.	20/Carton
38778BCK	15 White	Clear	1 Kit	20/Carton

**20 LED 7" Round Back-Up Light**

DESCRIPTION

- 7" Back-Up Light with 20 Super White LED
- Epoxy Sealed, Specially Designed Lens
- Specially Designed Lens, **Lifetime Warranty**

Item #	LEDs	Lens	Pack	Carton
38395B	20 White	Clear	1 Pc.	20/Carton

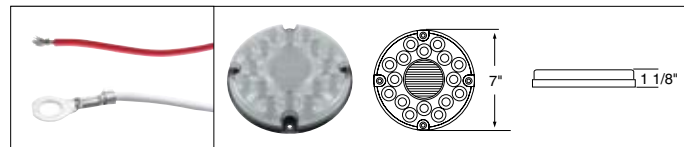

4 LED License Light

DESCRIPTION

- 4 Super Bright LED License Light, Chrome Housing, Water Resistant
- Mounting Holes are 2" Apart (Center to Center), Install Anywhere
- 2 Wires (Hard Wired), **6 Month Warranty**

Item #	LEDs	License Light	Pack	Carton
39930B	4 White	None	1 Pc.	20/Carton



2 LED License Light

DESCRIPTION

- 2 Super Bright LED License Light, Chrome Housing, Water Resistant
- Mounting Holes are 3 1/2" Apart (Center to Center), Install Anywhere
- 2 Wires (Hard Wired), **6 Month Warranty**

Item #	LEDs	Lens	Pack	Carton
39994B	2 White	None	1 Pc.	20/Carton



4 LED Round License Light

DESCRIPTION

- 4 Super Bright LED License Light
- Snap-Fit, Designed for 1 1/4" Diameter Light Cutouts
- 2 Wires (Hard Wired), **6 Month Warranty**

Item #	LEDs	Description	Pack	Carton
39995B	4 LED	Round License Light	1 Pc.	20/Carton

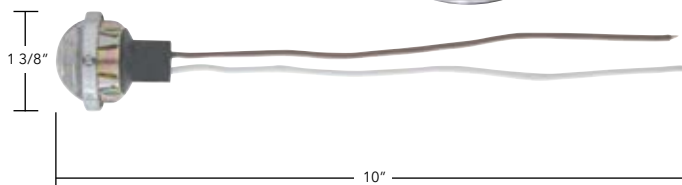

9 LED 2" Auxiliary/Utility Light

DESCRIPTION

- 9 Super Bright White LED 2" Round Auxiliary/Utility Light
- Recommended Plug: Item # 34210, **Lifetime Warranty**

Item #	LEDs	Lens	Pack	Carton
38030B	9 White	Clear	1 Pc.	20/Carton



13 LED 2 1/2" Auxiliary/Utility Light

DESCRIPTION

- 13 Super Bright White LED 2 1/2" Round Auxiliary/Utility Light
- Recommended Plug: Item # 34210, **Lifetime Warranty**

Item #	LEDs	Lens	Pack	Carton
38031B	13 White	Clear	1 Pc.	20/Carton

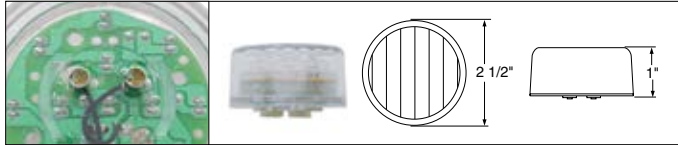
**12 LED 4" White Auxiliary/Utility Light - Reflector**

DESCRIPTION

- 12 White LED 4" Auxiliary/Utility Light with Reflector
- Epoxy Sealed, Unique Reflector Design, 2 Contact Female Terminal
- Recommended Plug: Item # 34212/34216, **Lifetime Warranty**

Item #	LEDs	Lens	Pack	Carton
39510B	12 White	Clear	1 Pc.	20/Carton
39510BCK	12 White	Clear	1 Kit	20/Carton

**10 LED 4" White Auxiliary/Utility Light**

DESCRIPTION

- 10 Super Bright White LED 4" Auxiliary/Utility Light
- Specially Designed Lens, Hard Wired with 2 Contact Female Plug
- Recommended Plug: Item # 34212/34216, **Lifetime Warranty**

Item #	LEDs	Lens	Pack	Carton
38828B	10 White	Clear	1 Pc.	20/Carton
38828BCK	10 White	Clear	1 Kit	20/Carton

**12 LED Rectangular Auxiliary/Utility Light**

DESCRIPTION

- 12 Super Bright White LED Rectangular Auxiliary/Utility Light
- Available in Clear Lens with 2 Female Terminals
- Mounting Base Item # 30919/33006, **Lifetime Warranty**

Item #	LEDs	Lens	Pack	Carton
39931B	12 White	Clear	1 Pc.	20/Carton

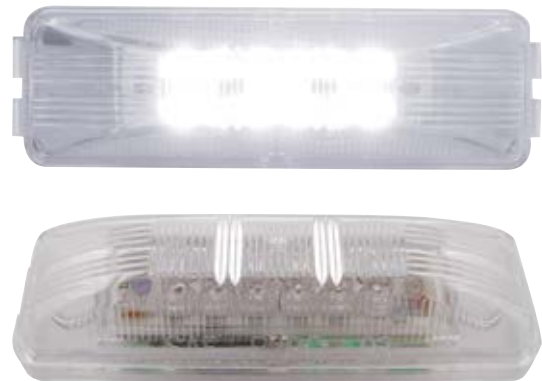



LED WORKLIGHTS



COMPETITION SERIES

9 High Power 3 Watt LED "Competition Series" Work Light - 1700 Lumens

DESCRIPTION

- 9 High Power 3 Watt LED Round Work Light, Competition Series
- 12V-30V Application
- 1700 Lumens, **3 Years Warranty**
- **Warning:** High Power LED Emits a Large Amount of Heat
- **Warning:** Please Handle the Light with Care After Operating the Light for an Extended Period

Item #	LEDs	Lumens	Function	Voltage	IP Rating	Pack
36671	3 Watt x 9	1700	Flood	12V - 30V	IP68	1 Pc./Card



COMPETITION SERIES

9 High Power 3 Watt LED "Competition Series" Work Light - 1800 Lumens

DESCRIPTION

- 9 High Power 3 Watt LED Round Work Light, Slim Profile
- 10V-16V Application
- 1800 Lumens, **3 Years Warranty**
- **Warning:** High Power LED Emits a Large Amount of Heat
- **Warning:** Please Handle the Light with Care After Operating the Light for an Extended Period

Item #	LEDs	Lumens	Function	Voltage	IP Rating	Pack
36965	3 Watt x 9	1800	Flood	10V-16V	IP67	1 Pc./Card



6 High Power 5 Watt LED Round Work Light - 1400 Lumens

DESCRIPTION

- 6 High Power, Extra Bright 5 Watt LED Work Light with Visor
- 12V/24V Application
- 1400 Lumens, **3 Years Warranty**
- **Warning:** High Power LED Emits a Large Amount of Heat
- **Warning:** Please Handle the Light with Care After Operating the Light for an Extended Period

Item #	LEDs	Lumens	Function	Voltage	IP Rating	Pack
37562	5 Watt x 6	1400	Flood	12V - 24V	IP67	1 Pc./Card

4 High Power 3 Watt LED Compact Work Light - 1000 Lumens

DESCRIPTION

- 4 High Power 3 Watt LED Compact Work Light
- Flood Function IP67 IP Rating
- 12V-24V Application
- 1000 Lumens, **6 Months Warranty**
- **Warning:** High Power LED Emits a Large Amount of Heat
- **Warning:** Please Handle the Light with Care After Operating the Light for an Extended Period



Item #	LEDs	Lumens	Function	Voltage	IP Rating	Pack
37087	3 Watt x 4	1000	Flood	12V - 24V	IP67	1 Pc./Card

3 High Power LED Compact Work Light - 600 Lumens

DESCRIPTION

- 3 High Power 3 Watt LED Round Work Light
- Compact Design only Measures 3 3/8" x 5 3/8" x 2 1/4"
- 9V-32V Application, 600 Lumens
- 600 Lumens, **3 Years Warranty**
- **Warning:** High Power LED Emits a Large Amount of Heat
- **Warning:** Please Handle the Light with Care After Operating the Light for an Extended Period

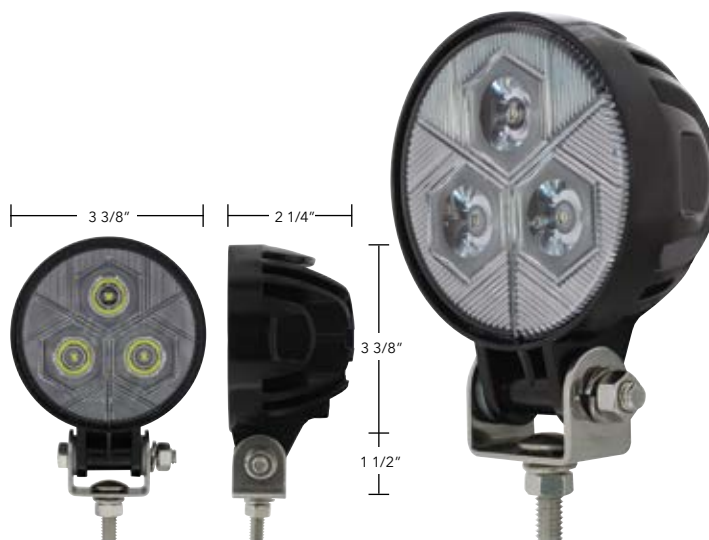

Item #	LEDs	Lumens	Function	Voltage	IP Rating	Pack
37074	3 Watt x 3	600	Flood	9V - 32V	IP67	1 Pc./Card

6 High Power 1 Watt LED Round Work Light - 500 Lumens

DESCRIPTION

- 6 High Power, Extra Bright 3 Watt LED Round Work Light with Visor
- 12V-24V Application, 600 Lumens, IP67 Rating
- 5/16" Mounting Stud, Mounting Hardware Allows Mounting in Any Position
- 500 Lumens, **3 Years Warranty**
- **Warning:** High Power LED Emits a Large Amount of Heat
- **Warning:** Please Handle the Light with Care After Operating the Light for an Extended Period



Item #	LEDs	Lumens	Function	Voltage	IP Rating	Pack
39688	1 Watt x 6	500	Flood	12V-24V	IP67	1 Pc./Card
39688B	1 Watt x 6	500	Flood	12V-24V	IP67	Bulk



6 High Power 1Watt LED Round Work Light - 480 Lumens

DESCRIPTION

- 6 High Power, Extra Bright 1 Watt LED Spot/Utility Light
- Universal 3/8" Mounting Stud
- Hard Wired with 2 Wires
- 480 Lumens, **3 Years Warranty**
- **Warning:** High Power LED Emits a Large Amount of Heat
- **Warning:** Please Handle the Light with Care After Operating the Light for an Extended Period

Item #	LEDs	Lumens	Function	Voltage	IP Rating	Pack
39979	1 Watt x 6	480	Spot	12V	IP65	1 Pc./Card



6 High Power 5 Watt LED Rectangular Work Light - 1700 Lumens

DESCRIPTION

- 6 High Power, Extra Bright 5 Watt LED Rectangular Work Light
- 12V/24V Application
- 1700 Lumens, **3 Years Warranty**
- **Warning:** High Power LED Emits a Large Amount of Heat
- **Warning:** Please Handle the Light with Care After Operating the Light for an Extended Period

Item #	LEDs	Lumens	Function	Voltage	IP Rating	Pack
37563	5 Watt x 6	1700	Flood	12V - 24V	IP67	1 Pc./Card



6 High Power 2.5Watt SMD LED Rectangular Work Light - 1200 Lumens

DESCRIPTION

- 6 High Power 2.5 Watt SMD LED Rectangular Flood Light
- Heavy Duty Die Cast Housing
- Stainless Steel Mounting Hardware
- 12V-36V Application
- 1200 Lumens, **3 Years Warranty**
- **Warning:** High Power LED Emits a Large Amount of Heat
- **Warning:** Please Handle the Light with Care After Operating the Light for an Extended Period

Item #	LEDs	Lumens	Function	Voltage	IP Rating	Pack
37123	2.5 Watt x 6	1200	Flood	12V - 36V	IP67	1 Pc./Card
37123B	2.5 Watt x 6	1200	Flood	12V - 36V	IP67	Bulk

6 High Power 1 Watt LED Rectangular Work Light - 500 Lumens

DESCRIPTION

- 6 High Power Extra Bright 1 Watt LED Rectangular Working Light
- Universal 7/8" Mounting Stud Mounting Hardware Allows Mounting in Any Position
- 500 Lumens, **3 Years Warranty**
- **Warning:** High Power LED Emits a Large Amount of Heat
- **Warning:** Please Handle the Light with Care After Operating the Light for an Extended Period



Item #	LEDs	Lumens	Function	Voltage	IP Rating	Pack
39901	1 Watt x 6	500	Flood	12V - 24V	IP67	1 Pc./Card
39901B	1 Watt x 6	500	Flood	12V - 24V	IP67	Bulk

5 High Power 1 Watt LED Rectangular Work Light - 400 Lumens

DESCRIPTION

- 5 High Power, Extra Bright 1 Watt LED
- Rectangular Auxiliary/Utility Light
- 12V/24V Application, Hard Wired with 2 Wires
- Adjustable Bracket Provides Multiple Installation Option
- 400 Lumens, **5 Years Warranty**
- **Warning:** High Power LED Emits a Large Amount of Heat
- **Warning:** Please Handle the Light with Care After Operating the Light for an Extended Period



Item #	LEDs	Lumens	Function	Voltage	IP Rating	Pack
39993	1 Watt x 5	400	Utility	12V - 24V	Not Rated	1 Pc./Card

9 High Power 3Watt LED Square Work Light - 1800 Lumens

DESCRIPTION

- 9 High Power 3 Watt LED Working Light, Available with Flood or Spot Light Function
- 12V - 36V Application
- 1800 Lumens, **3 Year Warranty**
- **Warning:** High Power LED Emits a Large Amount of Heat
- **Warning:** Please Handle the Light with Care After Operating the Light for an Extended Period



Item #	LEDs	Lumens	Function	Voltage	IP Rating	Pack
37174B	3 Watt x 9	1800	Flood	12V - 36V	IP67	Bulk
37175B	3 Watt x 9	1800	Spot	12V - 36V	IP67	Bulk



COMPETITION SERIES

9 High Power 3 Watt LED "Competition Series" Work Light - 1700 Lumens

DESCRIPTION

- 9 High Power 3 Watt LED Work Light, Competition Series
- 12V-30V Application,
- 1700 Lumens, **3 Years Warranty**
- **Warning:** High Power LED Emits a Large Amount of Heat
- **Warning:** Please Handle the Light with Care After Operating the Light for an Extended Period

Item #	LEDs	Lumens	Function	Voltage	IP Rating	Pack
36672	3 Watt x 9	1700	Flood	12V - 30V	IP68	1 Pc./Card



9 High Power 3Watt LED Square Work Light - 1580 Lumens

DESCRIPTION

- 9 High Power LED Flood Light, 3W
- 12V/36V Application
- 1580 Lumens, **3 Years Warranty**
- **Warning:** High Power LED Emits a Large Amount of Heat
- **Warning:** Please Handle the Light with Care After Operating the Light for an Extended Period

Item #	LEDs	Lumens	Function	Voltage	IP Rating	Pack
37597	3 Watt x 9	1580	Flood	12V - 36V	IP67	1 Pc./Card
37598	3 Watt x 9	1580	Spot	12V - 36V	IP67	1 Pc./Card



6 High Power 3 Watt LED Square Work Light - 1200 Lumens

DESCRIPTION

- 6 High Power 3 Watt LED Square Work Light
- 12V - 36V Application
- 1200 Lumens, **3 Year Warranty**
- **Warning:** High Power LED Emits a Large Amount of Heat
- **Warning:** Please Handle the Light with Care After Operating the Light for an Extended Period

Item #	LEDs	Lumens	Function	Voltage	IP Rating	Pack
37622	3 Watt x 6	1200	Flood	12V - 36V	IP67	1 Pc./Card
37622B	3 Watt x 6	1200	Flood	12V - 36V	IP67	Bulk

1 High Power 10Watt LED Mini Work Light - 800 Lumens

DESCRIPTION

- 1 High Power 10 Watt LED Mini Work Light
- 12V-36V Application
- 800 Lumens, **3 Years Warranty**
- **Warning:** High Power LED Emits a Large Amount of Heat
- **Warning:** Please Handle the Light with Care After Operating the Light for an Extended Period



Item #	LEDs	Lumens	Function	Voltage	IP Rating	Pack
37088	10 Watt x 1	800	Flood	12V - 36V	IP67	1 Pc./Card
37088B	10 Watt x 1	800	Flood	12V - 36V	IP67	Bulk

3 High Power 3 Watt LED Compact Work Light - 600 Lumens

DESCRIPTION

- 3 High Power 3 Watt LED Compact Flood Work Light
- 12V/36V Application, 240 Lumen per LED
- 720 Lumens, **3 Years Warranty**
- **Warning:** High Power LED Emits a Large Amount of Heat
- **Warning:** Please Handle the Light with Care After Operating the Light for an Extended Period



Item #	LEDs	Lumens	Function	Voltage	IP Rating	Pack
37157	3 Watt x 3	600	Flood	12V - 36V	IP67	1 Pc./Card
37157B	3 Watt x 3	600	Flood	12V - 36V	IP67	Bulk

4 High Power 3 Watt LED Compact Work Light - 700 Lumens

DESCRIPTION

- 4 High Power 3 Watt LED Compact Work Light
- Compact Design only Measures 2 13/16" x 4 3/4" x 1 1/8"
- 9V-32V Application
- 700 Lumens, **3 Years Warranty**
- **Warning:** High Power LED Emits a Large Amount of Heat
- **Warning:** Please Handle the Light with Care After Operating the Light for an Extended Period



Item #	LEDs	Lumens	Function	Voltage	IP Rating	Pack
36854	3 Watt x 4	700	Flood	9V - 32V	IP69K	1 Pc./Card



9 High Power 0.5Watt LED SquareWork Light - 500 Lumens
DESCRIPTION

- 9 High Power 0.5 Watt LED Square Work Light
- 12V - 24V Application
- Black Plastic Housing
- 500 Lumens, **3 Year Warranty**
- **Warning:** High Power LED Emits a Large Amount of Heat
- **Warning:** Please Handle the Light with Care After Operating the Light for an Extended Period

Item #	LEDs	Lumens	Function	Voltage	IP Rating	Pack
37552B	0.5 Watt x 9	500	Flood	12V - 24V	IP67	Bulk

Item #	LEDs	Lumens	Length	Pack
36763	12	2160 lm	8"	1 Pc./Box
36764	24	4320 lm	14"	1 Pc./Box
36765	40	7200 lm	24"	1 Pc./Box
36766	60	10800 lm	32"	1 Pc./Box
36767	80	14400 lm	42"	1 Pc./Box
36768	96	17280 lm	50"	1 Pc./Box

High Power LED Light Bar - Curved

DESCRIPTION

- 3W High Power Double Row, Curved LED Light Bar
- 10V - 30V Application, IP 67 Rated
- 3" Tall 3 7/8" Wide, Light is 4 3/4" Tall with Mounting Bracket
- Available in 6 Different Lengths, Heavy Duty Aluminum Housing, **3 Years Warranty**



Item #	LEDs	Lumens	Length	Pack
36640	12	2520 lm	10"	1 Pc./Box
36641	24	5040 lm	16"	1 Pc./Box
36642	40	8400 lm	24"	1 Pc./Box
36643	60	12600 lm	34"	1 Pc./Box
36644	80	16800 lm	44"	1 Pc./Box

High Power LED Light Bar - Competition Series

DESCRIPTION

- 3W High Power LED Light Bar
- 10V - 30V Application, IP 67 Rated
- 3 1/4" Tall, 3 1/2" Wide. Light is 4 3/8" Tall with Mounting Bracket
- Available in 5 Different Lengths, Heavy Duty Aluminum Housing, **3 Years Warranty**



High Power 4 Row LED Light Bar - Reflector Series

DESCRIPTION

- 1.5W High Power LED, 4 Row LED Light Bar
- 10V - 24V Application, Reflector Illumination, IP 67 Rated
- 3 1/8" Tall x 2 1/4" Wide, Light is 5 1/8" Tall with Mounting Bracket
- Available in 6 Different Lengths, Heavy Duty Aluminum Housing, **3 Years Warranty**

Item #	LEDs	Lumens	Length	Pack
36646	24	2160 lm	8"	1 Pc./Box
36647	48	4320 lm	14"	1 Pc./Box
36648	80	7200 lm	22"	1 Pc./Box
36649	120	10800 lm	32"	1 Pc./Box
36650	160	14400 lm	42"	1 Pc./Box
36651	200	18000 lm	52"	1 Pc./Box

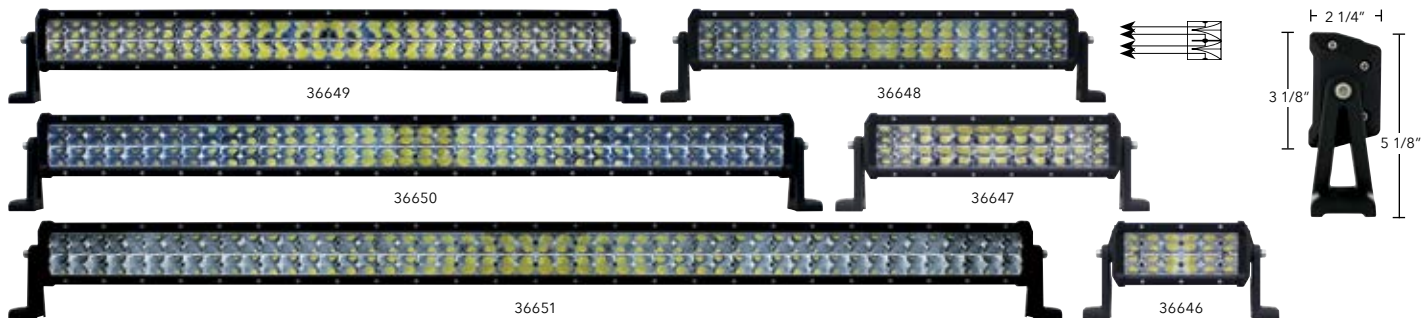

High Power Double Row LED Light Bar

DESCRIPTION

- 3W High Power "Cree" LED, Double Row LED Light Bar
- 12V - 24V Application, IP 67 Rated
- Manufactured with USA Made "Cree" LEDs
- 3 1/8" Tall x 3 1/2" Wide, Light is 4 3/4" Tall with Mounting Bracket
- Available in 6 Different Lengths, Heavy Duty Aluminum Housing, **3 Years Warranty**

Manufactured with
USA Made
CREE LEDs

Item #	LEDs	Lumens	Length	Pack
36781	12	2640 lm	7 1/2"	1 Pc./Box
36782	24	5280 lm	13 1/2"	1 Pc./Box
36783	40	8800 lm	21 1/2"	1 Pc./Box
36784	60	13200 lm	31 1/2"	1 Pc./Box
36785	80	17600 lm	41 1/2"	1 Pc./Box
36786	96	21120 lm	50 1/2"	1 Pc./Box

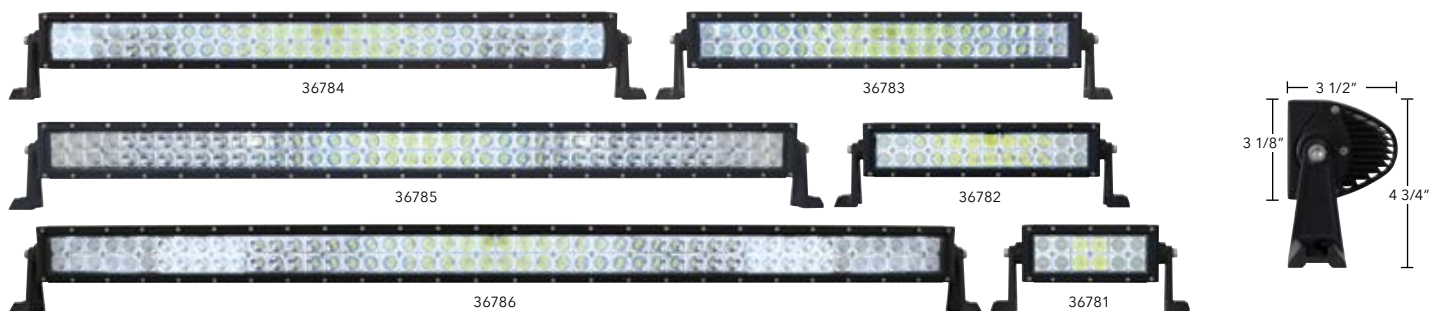

High Power LED Light Bar - Stud Mount

DESCRIPTION

- 3W High Power LED Light Bar
- 10V - 30V Application, IP 67 Rated
- 3 1/8" Tall, 2 3/8" Wide. Light is 4 3/8" Tall with Mounting Bracket
- Available in 6 Different Lengths, Heavy Duty Aluminum Housing, **3 Years Warranty**

Item #	LEDs	Lumens	Length	Pack
36634	6	1260 lm	4"	1 Pc./Box
36635	12	2520 lm	7"	1 Pc./Box
36636	18	3780 lm	9"	1 Pc./Box
36637	24	5040 lm	13"	1 Pc./Box
36638	30	6300 lm	18"	1 Pc./Box
36639	36	7560 lm	20"	1 Pc./Box



LED ACCESSORY / INTERIOR LIGHT

**39 High Power LED Dome Light**

DESCRIPTION

- 39 High Power LED, 7 1/4" Round Dome Light with Chrome Bezel
- 12V/24V Application, **6 Month Warranty**

Item #	LEDs	Description	Pack	Carton
37626B	39	LED Dome Light	1 Pc.	20/Carton

**21 High Power LED Dome Light**

DESCRIPTION

- 21 High Power LED, 6 1/4" Round Dome Light with Chrome Bezel
- 12V/24V Application, **6 Month Warranty**

Item #	LEDs	Description	Pack	Carton
37625B	21	LED Dome Light	1 Pc.	20/Carton

**4 LED Dome Light**

DESCRIPTION

- 4 Super Bright LED Auxiliary Light with Chrome Plastic Bezel
- 2 Wires (Hard Wired), Mounting Holes are 2 3/16" Apart, **6 Month Warranty**

Item #	LEDs	Lens	Pack	Carton
38936B	4 White	Clear	1 Pc.	20/Carton





INCANDESCENT PRODUCTS



INCANDESCENT CLEARANCE MARKERS

2" Clearance/Marker Light - Flat

DESCRIPTION

- 2" Flat Clearance/Marker Light with 2 Female Terminals
- Kits Include Light, Grommet (Item # 31505) and Plug (Item # 34210)
- **Recommended Plug: Item # 34210**

Item #	Lens	Pack	Carton
30191	Amber	1 Pc.	100/Carton
30911	Red	1 Pc.	100/Carton
30191AK	Amber	1 Kit	100/Carton
30911RK	Red	1 Kit	100/Carton



2" Clearance/Marker Light - Beehive

DESCRIPTION

- 2" Beehive Clearance/Marker Light with 2 Female Terminals
- Kits Include Light, Grommet (Item # 31505) and Plug (Item # 34210)
- **Recommended Plug: Item # 34210**

Item #	Lens	Pack	Carton
30913	Amber	1 Pc.	50/Carton
30918	Red	1 Pc.	50/Carton
36701	Amber	1 Kit	50/Carton
36702	Red	1 Kit	50/Carton

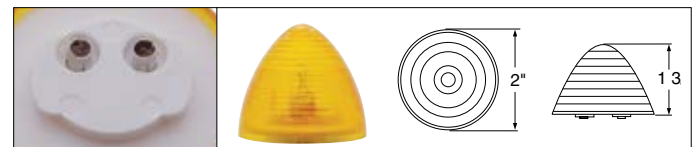

2 1/2" Clearance/Marker Light - Flat

DESCRIPTION

- 2 1/2" Flat Clearance/Marker Light with 2 Female Terminals
- Kits Include Light, Grommet (Item # 31503) and Plug (Item # 34210)
- **Recommended Plug: Item # 34210**

Item #	Lens	Pack	Carton
31061	Amber	1 Pc.	100/Carton
31065	Red	1 Pc.	100/Carton
31061AK	Amber	1 Kit	100/Carton
31065RK	Red	1 Kit	100/Carton

**2 1/2" Reflectorized Clearance/Marker Light**

DESCRIPTION

- 2 1/2" Flat Clearance/Marker Light with Reflectorized Lens and 2 Female Terminals
- Kits Include Light, Grommet (Item # 31503) and Plug (Item # 34210)
- **Recommended Plug: Item # 34210**

Item #	Lens	Pack	Carton
31055	Amber Reflectorized	1 Pc.	100/Carton
31059	Red Reflectorized	1 Pc.	100/Carton
31055AK	Amber Reflectorized	1 Kit	100/Carton
31059RK	Red Reflectorized	1 Kit	100/Carton

**2 1/2" Clearance/Marker Light - Beehive**

DESCRIPTION

- 2 1/2" Beehive Clearance/Marker Light with 2 Female Terminals
- Kits Include Light, Grommet (Item # 31503) and Plug (Item # 34210)
- **Recommended Plug: Item # 34210**

Item #	Lens	Pack	Carton
30169	Amber	1 Pc.	20/Carton
30168	Red	1 Pc.	20/Carton

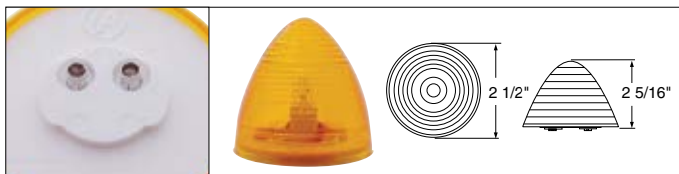

Rectangular Clearance/Marker Light - Single Wire

DESCRIPTION

- Tiger Eye Clearance/Marker Light with 2 Incandescent 194 Bulbs
- Acrylic Lens Snap Seals onto ABS Housing
- Single Wire, Self Grounding

Item #	Lens	Base	Pack	Carton
30005	Amber	White	1 Pc.	50/Carton
30008	Red	White	1 Pc.	50/Carton



Rectangular Clearance/Marker Light

DESCRIPTION

- Rectangular Clearance/Marker Light with 2 Bulbs
- Kit Includes Light and Mounting Base (Item # 30919 or 33006)
- Recommended Mounting Base: Item # 30919 (Chrome) or Item # 33006 (Black)

Item #	Lens	Base	Pack	Carton
30051	Amber	None	1 Pc.	100/Carton
30055	Red	None	1 Pc.	100/Carton
30051AK-B	Amber	Black	1 Kit	100/Carton
30051AK-C	Amber	Chrome	1 Kit	100/Carton
30055RK-B	Red	Black	1 Kit	100/Carton
30055RK-C	Red	Chrome	1 Kit	100/Carton

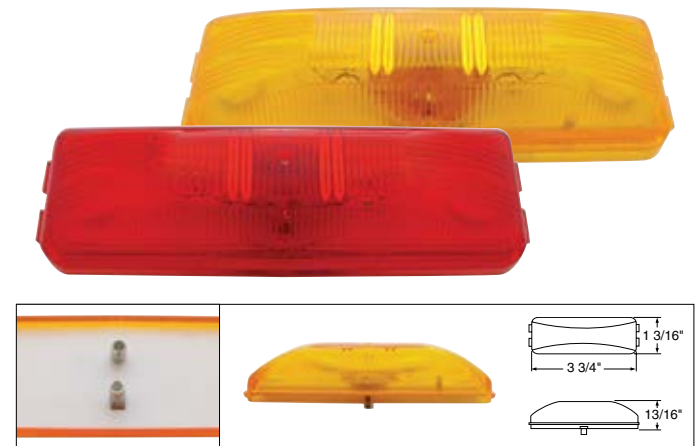

Fender Mount Rectangular Clearance/Marker Light

DESCRIPTION

- Functions as Both Front and Rear Clearance Light for Over 80" Application
- Two Grease Filled Terminal to Prevent Corrosion
- Kit Includes Light and Mounting Base (Item # 30919 or 33006)
- Recommended Mounting Base: Item # 30919 (Chrome) or Item # 33006 (Black)

Item #	Description	Base	Pack	Carton
31050	Fender - Mount	None	1 Pc.	100/Carton
31050ARK-B	Fender - Mount	Black	1 Kit	100/Carton
31050ARK-C	Fender - Mount	Chrome	1 Kit	100/Carton

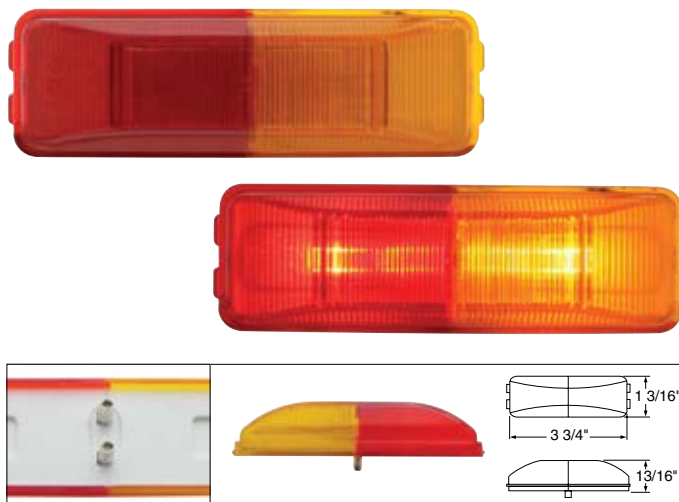

Rectangular Clearance/Marker Light

DESCRIPTION

- Rectangular Clearance/Marker Light with 1 Incandescent 193 Bulb
- Slim Design for Narrow Rail Application
- Mounts on Industry Standard 3" Center
- 2 Wires (Hard Wired)

Item #	Lens	Pack	Carton
31081	Amber	1 Pc.	100/Carton



Rectangular Clearance/Marker Light with Reflex Lens

DESCRIPTION

- Rectangular Clearance/Marker Light with Black Housing
- Single Stud, Shock Absorbing Housing
- Single Wire, Self Grounding

Item #	Lens	Pack	Carton
36012	Amber	1 Pc.	100/Carton
36013	Red	1 Pc.	100/Carton

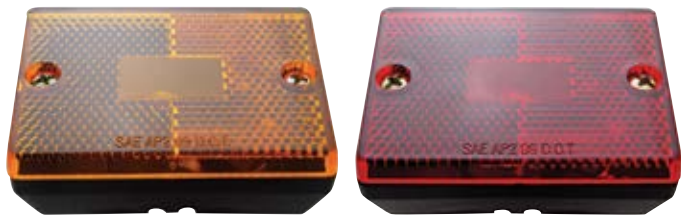
**Rectangular Clearance/Marker Light with Reflex Lens**

DESCRIPTION

- Rectangular Clearance/Marker Light with Clear Housing
- Single Stud, Shock Absorbing Housing
- Single Wire, Self Grounding

Item #	Lens	Pack	Carton
36008	Amber	1 Pc.	100/Carton

**Rectangular Clearance/Marker Light**

DESCRIPTION

- Rectangular Clearance/Marker Light with 1 Bulb and 2 Female Terminals
- Recommended Mounting Base: Item # 33002

Item #	Lens	Pack	Carton
30141	Amber	1 Pc.	100/Carton
30145	Red	1 Pc.	100/Carton
30141AK-C	Amber	1 Kit	100/Carton
30145RK-B	Red	1 Kit	100/Carton
30145RK-C	Red	1 Kit	100/Carton

**Rectangular Clearance/Marker Light - Stud Mount**

DESCRIPTION

- Stud Mounted Rectangular Clearance/Marker Light
- Single Wire, Self Grounding

Item #	Lens	Pack	Carton
30101	Amber	1 Pc.	100/Carton
30102	Red	1 Pc.	100/Carton

**Rectangular Clearance/Marker Light**

DESCRIPTION

- Snap Seal Rectangular Clearance/Marker Light
- Single Wire, Self Grounding

Item #	Lens	Base	Pack	Carton
30020	Amber	White	1 Pc.	100/Carton
30023	Red	White	1 Pc.	100/Carton



1 3/4" Narrow-Rail Clearance/Marker Light

DESCRIPTION

- Gray Steel Housing with Mounting Pad and High Guard
- Flat Back Design Eliminates the Need for Socket Holes
- 1 3/4" deep housing with 3 7/8" mounting hole
- Single Wire, Self Grounding

Item #	Lens	Pack	Carton
36014	Amber	1 Pc.	100/Carton
36015	Red	1 Pc.	100/Carton



2 3/16" Narrow-Rail Clearance/Marker Light

DESCRIPTION

- Gray Steel Housing with Mounting Pad and High Guard
- Flat Back Design Eliminates the Need for Socket Holes
- 2 3/16" deep housing with 3 7/8" mounting hole
- Single Wire, Self Grounding

Item #	Lens	Pack	Carton
36016	Amber	1 Pc.	100/Carton
36017	Red	1 Pc.	100/Carton



1 7/16" Chrome Narrow-Rail Clearance/Marker Light

DESCRIPTION

- Chrome Plastic Housing and High Guard Narrow Rail Light
- Flat Back Design Eliminates the Need for Socket Holes
- 1 7/16" deep housing with 3 7/8" mounting hole
- Single Wire, Self Grounding

Item #	Lens	Pack	Carton
36020	Amber	1 Pc.	100/Carton
36021	Red	1 Pc.	100/Carton





INCANDESCENT CLEARANCE MARKERS

4" S/T/T & P/T/C Light

DESCRIPTION

- Incandescent 4" S/T/T or P/T/C Light with 3 Contact Female Terminal
- Shock Mount Designed to Absorb Shock and Prolong Bulb Life
- Kit Includes Lamp, Grommet (Item # 31515) and Plug (Item # 34212)
- **Recommended Plug: Item # 34212**

Item #	Lens	Pack	Carton
31101	Amber	1 Pc.	50/Carton
31109	Red	1 Pc.	50/Carton
31101AK	Amber	1 Kit	50/Carton
31109RK	Red	1 Kit	50/Carton

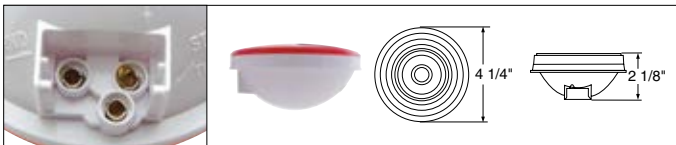

4" S/T/T & P/T/C Light - Deep Dish

DESCRIPTION

- Flush Mount Housing with Recessed Lens, Black Painted Steel Housing
- Lens Hold in Place by Snap-In Retaining Ring
- 2 Wires (Hard Wired)

Item #	Lens	Pack	Carton
31123	Red	1 Pc.	50/Carton



Oval S/T/T & P/T/C Light

DESCRIPTION

- Incandescent Oval S/T/T & P/T/C Light with 3 Contact Female Terminal
- Grease Filled Terminal to Prevent Corrosion
- Kit Includes Grommet (Item # 31506) & Plug (Item # 34216)
- **Recommended Plug: Item # 34216**

Item #	Lens	Pack	Carton
31361	Amber	1 Pc.	50/Carton
31362	Red	1 Pc.	50/Carton
31361AK	Amber	1 Kit	50/Carton
31362RK	Red	1 Kit	50/Carton



Rectangular S/T/T & P/T/C Light

DESCRIPTION

- Incandescent Rectangular S/T/T & P/T/C Light with 3 Contact Female Terminal
- Grease Filled Terminals to Prevent Corrosion
- Kits Include Grommet (Item # 31516) & Plug (Item # 34216)
- **Recommended Plug: Item # 34216**

Item #	Lens	Pack	Carton
36409	Amber	1 Pc.	50/Carton
31364	Red	1 Pc.	50/Carton
36409AK	Amber	1 Kit	50/Carton
31364RK	Red	1 Kit	50/Carton



Universal Stud-Mount S/T/T Light

DESCRIPTION

- Functions as Stop, Turn, Tail, Back-Up and License Light
- Stud Mount, Self Grounding

Item #	Description	Pack	Carton
31125	w/o License Light	1 Pc.	50/Carton
31126	w/ License Light	1 Pc.	50/Carton

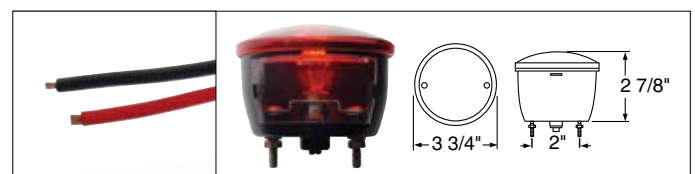

Oval Mid Trailer Turn Signal Light

DESCRIPTION

- Mid-Trailer Light Provides Side Marker Light and Side Reflector Functions
- Polycarbonate Lens, Sonically Welded to Housing, 3 Contact Female Terminal
- Kit Includes Lamp, Grommet (Item # 31506), and Plug (Item # 34216)
- **Recommended Plug: Item # 34216**

Item #	Description	Pack	Carton
31321	Amber	1 Pc.	50/Carton
31321AK	Amber	1 Kit	50/Carton



Universal Combination Tail Light

DESCRIPTION

- Functions as Stop, Turn, Tail, Back-Up, and License Light
- Acrylic Optic Reflectorized Lens
- Polycarbonate Black Housing with Rear Harness Connection
- Three Bolt Mount on 2" Triangle Pattern

Item #	Description	Pack	Carton
36379	Combination TailLight	1 Pc.	50/Carton



Rectangular Submersible Combination Light

DESCRIPTION

- Over 80" Wide Submersible Combination Tail Light
- Designed with Acrylic Lens and High Impact Housing
- Gaskets Create Air Pockets Preventing Water Entry
- Meets DOT Requirements for Stop, Turn and Tail Rear and Side Reflector, Side Marker, and License

Item #	Description	Pack	Carton
31165	w/o License Light	1 Pc.	50/Carton
31166	w/ License Light	1 Pc.	50/Carton

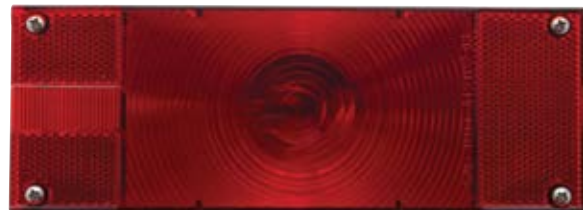

Combination Light

DESCRIPTION

- Includes Rear Clearance Light for Over 80" Wide Application
- Designed with Acrylic Lens and High Impact Housing
- Meets DOT Requirements for Stop, Turn and Tail, Rear and Side Reflector, Side Marker, and License

Item #	Description	Pack	Carton
31131	w/o License Light	1 Pc.	50/Carton
31132	w/ License Light	1 Pc.	50/Carton



Combination Light

DESCRIPTION

- Meets DOT Requirements for Stop, Turn and Tail, Rear and Side Reflector, Side Marker, and License
- Designed with Acrylic Lens and High Impact Housing
- Standard 2" Stud Mounting

Item #	Description	Pack	Carton
31133	w/o License Light	1 Pc.	50/Carton
31134	w/ License Light	1 Pc.	50/Carton



Submersible Combination Light

DESCRIPTION

- Over 80" Wide Submersible Combination Tail Light
- Designed with Acrylic Lens and High Impact Housing
- Gaskets Create Air Pocket Preventing Water Entry
- Meets DOT Requirements for Stop, Turn and Tail Rear and Side Reflector, Side Marker, and License

Item #	Description	Pack	Carton
31135	w/o License Light	1 Pc.	50/Carton
31136	w/ License Light	1 Pc.	50/Carton



Trailer Light Kit - Under 80"

DESCRIPTION

- For Utility or Similar Type Trailers under 80" Wide
- Kit Includes 2 Stop and Tail Lights, 2 Amber Side Marker Lights, 25' Trailer Wire Harness, 4' Trunk Connector, License Bracket, All Mounting Gear

Item #	Description	Pack	Carton
33130	Under 80" TrailerLight	1 Kit	10/Carton

**Trailer Light Kit - Over 80"**

DESCRIPTION

- Over 80" Wide Trailer Light Kit for All Trailers
- Kit Includes 2 Stop and Tail Lights, 25' Trailer Wire Harness, 4' Trunk Connector, License Bracket, All Mounting Gear

Item #	Description	Pack	Carton
33131	Over 80" Trailer Light	1 Kit	10/Carton

**Submersible Trailer Light Kits**

DESCRIPTION

- Over 80" Wide Submersible Combination Tail Light
- Designed with Acrylic Lens and High Impact Housing
- Gaskets Create Air Pocket Preventing Water Entry
- Meets DOT Requirements for Stop, Turn and Tail Rear and Side Reflector, Side Marker, and License

Item #	Description	Pack	Carton
33133	Over 80" TrailerLight	1 Kit	10/Carton

**Double Face Tow Light Kit**

DESCRIPTION

- Magnetic Tow Light Kit, Ideal for Tow Trucks, Mobile Homes, and RV's
- Kit Features Two Double Face Warning Lights with Magnetic Base, Trunk and Trailer Harness, and Connectors
- 25' Four-Wire Harness Plugs into Standard Flat Four Way Trailer Connector

Item #	Description	Pack	Carton
33135	TowLight	1 Kit	10/Carton

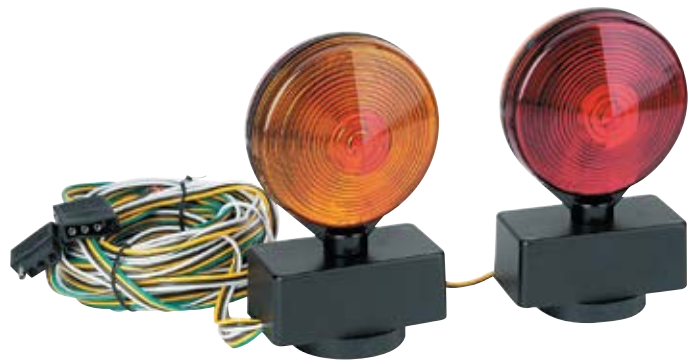



INCANDESCENT IDENTIFICATION LIGHT BAR



Beehive Light Bar

DESCRIPTION

- Identification Bar Light for Over 80" Applications
- Designed for Installations with Minimal Space Requirement
- Black Powder-Coated Steel Bar with Three Beehive-Style Lights Attached
- Mounts on 14 9/16" Centers
- Grounds through Mounting Hardware
- Pre-Wired Light Bar for Easy Installation

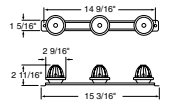

Item #	Lens	Pack	Carton
31078	Red	1 Pc.	50/Carton

Mini Light Bar

DESCRIPTION

- Identification Bar Light for over 80" Applications
- Designed for Installation with Minimal Space Requirement
- Steel Bar is Powder Coated in White Finish with Three Lights
- Mounts on 14 3/8" Centers
- Grounds through Mounting Screw
- Pre-Wired Light Bar for Easy Installation

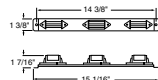

Item #	Lens	Pack	Carton
31076	Amber	1 Pc.	50/Carton
31077	Red	1 Pc.	50/Carton

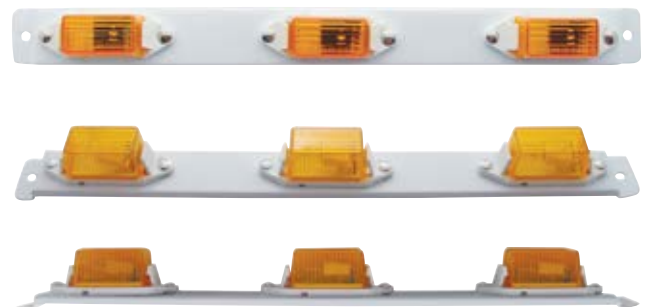

Sealed Light Bar

DESCRIPTION

- Identification Bar Light for Over 80" Applications
- Black Polycarbonate Bar with Three Sealed Lights
- Mounts on 8 1/2" Centers
- Grounds through Mounting Screw
- Pre-Wired Light Bar for Easy Installation

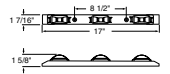

Item #	Lens	Pack	Carton
31079	Amber	1 Pc.	50/Carton
31080	Red	1 Pc.	50/Carton





INCANDESCENT BACK-UP & LICENSE LIGHT

4" Round Back-Up Light

DESCRIPTION

- Incandescent 4" Round Back-Up Light
- 3 Contact Female Terminal, Grease Filled Terminal to Prevent Corrosion
- Kit Includes Lamp, Grommet (Item # 31515) and Plug (Item # 34211)
- **Recommended Plug: Item # 34211/34216**

Item #	Description	Pack	Carton
31106	4" Back-Up	1 Pc.	50/Carton
31106CK	4" Back-Up	1 Kit	50/Carton



Oval Back-Up Light

DESCRIPTION

- Incandescent Oval Back-Up Light
- 3 Contact Female Terminal, Lens are Sonically Welded to Housing
- Kit Includes Lamp, Grommet (Item # 31506) and Plug (Item # 34211)
- **Recommended Plug: Item # 34211/34216**

Item #	Description	Pack	Carton
31251	Oval Back-Up	1 Pc.	50/Carton
31251CK	Oval Back-Up	1 Kit	50/Carton

Rectangular Back-Up Light

DESCRIPTION

- Incandescent Rectangular Back-Up Light with 3 Contact Female Terminal
- Bulb Shock Mounted to Absorb Shocks and Prolong Bulb Life
- Kit Includes Lamp, Grommet (Item # 31516) and Plug (Item # 34216)
- **Recommended Plug: Item # 34211/ 34216**

Item #	Description	Pack	Carton
36410	Rectangular Back-Up	1 Pc.	50/Carton
36410CK	Rectangular Back-Up	1 Kit	50/Carton



Rectangular Utility Light, Round Profile

DESCRIPTION

- Rectangular Utility Light
- Kit Includes Lamp, Lead Wire and Chrome Mounting Base (Item # 33002)
- **Recommended Base: Item # 33002**

Item #	Description	Pack	Carton
30143	Clear	1 Pc.	100/Carton



Rectangular Utility Light, Beveled Profile

DESCRIPTION

- Rectangular Utility Light with 2 Bulbs
- Kit Includes Lamp, Lead Wire and Chrome Mounting Base (Item # 30919)
- **Recommended Base: Item # 30919**

Item #	Description	Pack	Carton
31039	Clear	1 Pc.	100/Carton



Chrome License Light

DESCRIPTION

- Rectangular License Light with Chrome Housing
- 2 Wires (Hard Wired)

Item #	Description	Pack	Carton
30362	White	1 Pc.	100/Carton



Cylindrical Chrome License Light

DESCRIPTION

- License Light with Chrome Plated Steel Housing and Mounting Bracket
- Surface Mount on 2" Center
- 1 Wire, Ground Through Mounting Screws

Item #	Description	Pack	Carton
33136B	LicenseLight	1 Pc.	50/Carton



Dome License Light

DESCRIPTION

- Chrome Plated License Light
- 2 Units Required for Legal License Illumination
- Surface Mounts on 2 5/8" Mount

Item #	Description	Pack	Carton
33137	License Light	1 Pc.	50/Carton

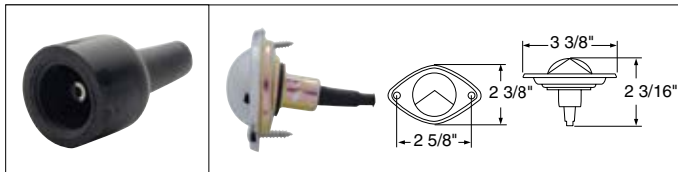

Snap-Fit License Light

DESCRIPTION

- Snap-Fit License Light Designed for 1 1/4" Diameter Hole
- Ideal for Courtesy, Interior Instrument, and License Light
- 2 Units Required for Legal License Illumination

Item #	Description	Pack	Carton
30361	Snap-In License Light	1 Pc.	100/Carton

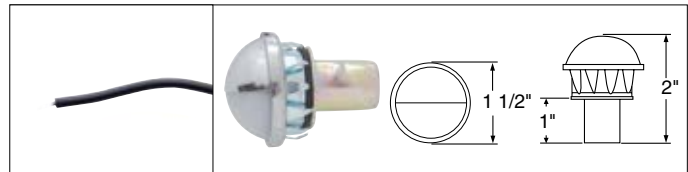

Rectangular License Light

DESCRIPTION

- Rectangular License Light, Available in Chrome or Gray ABS Housing
- Surface Mount on 1 3/4" Center
- 1 Wire, Ground Through Mounting Screw

Item #	Description	Pack	Carton
31401	Chrome	1 Pc.	50/Carton
33138	Gray	1 Pc.	100/Carton



License Light with Bracket

DESCRIPTION

- Polycarbonate Lens and ABS Housing
- Black Powder-Coated, Steel License Plate Bracket Riveted to Light
- Surface Mount on 3 1/2" Centers

Item #	Description	Pack	Carton
33139	License Light	1 Pc.	50/Carton





SPECIALTY LIGHTING

Interior Dome Light with On-Off Switch

DESCRIPTION

- 12 Volt Rectangular Dome Light with 1156 Bulb
- Chrome Housing with On-Off Switch
- Mount on 4" Center

Item #	Description	Pack	Carton
31427	Clear Lens	1 Pc.	25/Carton



Interior Dome Light

DESCRIPTION

- Durable Polycarbonate Lens with On-Off Toggle Switch
- 12 Volt Interior Dome Light Used for General Illumination
- Mounts on 3 1/2" Center

Item #	Description	Pack	Carton
31402	Dome Light	1 Pc.	50/Carton



PAR 36 Rubber Work Light

DESCRIPTION

- Durable Synthetic Rubber Housing Resists Corrosion
- Rubber Housing Cushions Trapezoidal Seal Beam from Shock and Vibration
- Mounts on Swivel Base Bracket
- Universal 5/16" Mounting Stud and Mounting Hardware Allows Mounting in Any Position

Item #	Description	Pack	Carton
36451	PAR 36 Rubber Work Light	1 Pc.	20/Carton





REFLECTOR

3" Round Quick Mount Reflector

DESCRIPTION

- 3" Round Quick Mount Reflector
- Acrylic Lens
- Hermetically Sealed Acrylic Lens with Adhesive Backing

Item #	Color	Size	Pack	Carton
30713	Amber	3 3/16"	1 Pc.	100/Carton
30714	Red	3 3/16"	1 Pc.	100/Carton



2 3/8" Round Quick Mount Reflector

DESCRIPTION

- 2 3/8" Round Quick Mount Reflector
- Acrylic Lens
- Hermetically Sealed Acrylic Lens with Adhesive Backing

Item #	Color	Size	Pack	Carton
30725	Amber	2 3/8"	1 Pc.	100/Carton
30726	Red	2 3/8"	1 Pc.	100/Carton

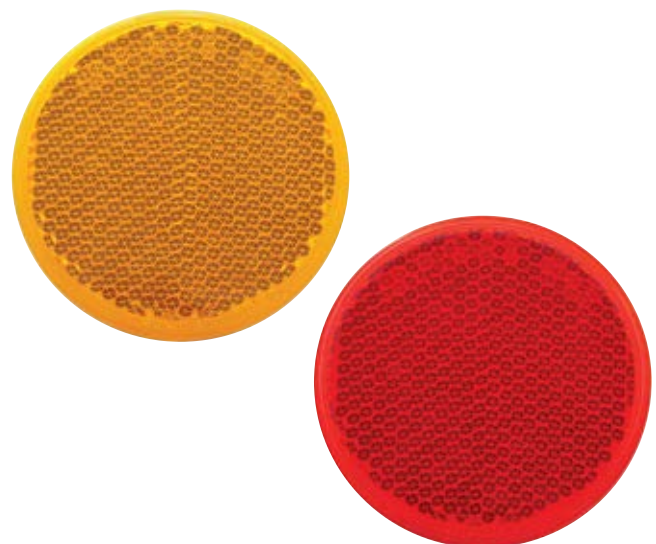

4" x 2" Oval Quick Mount Reflector

DESCRIPTION

- 4" x 2" Oval Quick Mount Reflector
- Acrylic Lens
- Hermetically Sealed Acrylic Lens with Adhesive Backing

Item #	Color	Size	Pack	Carton
30711	Amber	4 5/16" x 1 7/8"	1 Pc.	100/Carton
30712	Red	4 5/16" x 1 7/8"	1 Pc.	100/Carton

**4"x 2" Oval Quick Mount Reflector**

DESCRIPTION

- 4" x 2" Oval Quick Mount Reflector
- Acrylic Lens
- Hermetically Sealed Acrylic Lens with Adhesive Backing

Item #	Color	Size	Pack	Carton
30719	Amber	4"x 2"	1 Pair	100/Carton
30720	Red	4"x 2"	1 Pc.	100/Carton

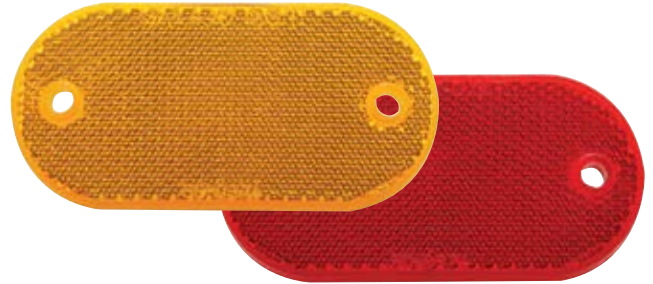
**2" Round Quick Mount Reflector w/ Chrome Bezel**

DESCRIPTION

- 2" Round Quick Mount Reflector with Chrome Plated ABS Bezel
- Acrylic Lens
- Hermetically Sealed Acrylic Lens with Adhesive Backing

Item #	Color	Size	Pack	Carton
30701	Amber	1 9/16"	1 Pc.	100/Carton

**Rectangular Quick Mount Reflector w/ Chrome Bezel**

DESCRIPTION

- 3 1/2" x 1 2/3" Rectangular Quick Mount Reflector with Chrome Bezel
- Acrylic Lens
- Hermetically Sealed Acrylic Lens with Adhesive Backing

Item #	Color	Size	Pack	Carton
30703	Amber	3 1/2" x 1 3/4"	1 Pc.	100/Carton
30704	Amber	3 1/2" x 1 3/4"	1 Pc.	100/Carton

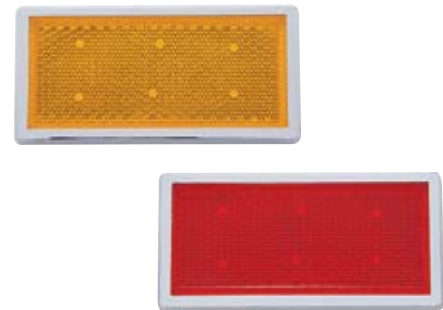
**3 3/16" Round Reflector w/ Aluminum Mounting Base**

DESCRIPTION

- 3 3/16" Round Reflector
- Acrylic Lens
- Hermetically Sealed Acrylic Lens with Aluminum Mounting Base

Item #	Color	Size	Pack	Carton
30709	Amber	3 3/16"	1 Pc.	100/Carton
30710	Red	3 3/16"	1 Pc.	100/Carton

**Round Center Bolt Reflector**

DESCRIPTION

- Round Center Bolt Reflector
- Acrylic Lens, Available in 2 3/8" or 3 3/16"
- Hermetically Sealed Acrylic Lens with Center Mounting Holes

Item #	Color	Size	Pack	Carton
30727	Amber	2 3/8"	1 Pc.	100/Carton
30728	Red	2 3/8"	1 Pc.	100/Carton
30723	Amber	3 3/16"	1 Pc.	100/Carton
30724	Red	3 3/16"	1 Pc.	100/Carton





MOUNTING ACCESSORIES

Chrome Mounting Bezel

DESCRIPTION

- Chrome Plastic Mounting Bezel
- Specially Design to Mount Lights without the Need of Rubber Grommets

Item #	Description	Pack	Carton
10501B	2" Mounting Bezel	1 Pc.	50/Carton
10500B	4" Mounting Bezel	1 Pc.	50/Carton



Gray Mounting Bezel

DESCRIPTION

- Gray Plastic Mounting Bezel
- Specially Design to Mount Lights without the Need of Rubber Grommets

Item #	Description	Pack	Carton
10518B	2" Mounting Bezel	1 Pc.	50/Carton
10519B	4" Mounting Bezel	1 Pc.	50/Carton



2" Grommet

DESCRIPTION

- Black Rubber Grommet for 2" Light
- Provide Lamps with Additional Shock and Vibration Absorbency

Item #	Color	Pack	Carton
31505	Flush Mount	1 Pc.	100/Carton
31507	Branch Deflector	1 Pc.	100/Carton

**2 1/2" Grommet**

DESCRIPTION

- Black Rubber Grommet for 2 1/2" Light
- Provide Lamps with Additional Shock and Vibration Resistance

Item #	Color	Pack	Carton
31503	Flush Mount, Wide Lip	1 Pc.	100/Carton
31504	Recess Mount, Narrow Lip	1 Pc.	100/Carton
31508	Recess Mount, Closed Back	1 Pc.	100/Carton

**4" Grommet**

DESCRIPTION

- Black Rubber Grommet Designed for 4" Light
- Provide Lamps with Additional Shock and Vibration Absorbency

Item #	Description	Pack	Carton
31515	4" Round	1 Pc.	100/Carton

**Oval Grommet**

DESCRIPTION

- Black Rubber Grommet Designed for Oval Light
- Provide Lamps with Additional Shock Absorbency and Vibration Resistance

Item #	Description	Pack	Carton
31506	Oval	1 Pc.	100/Carton



Rectangular Grommet

DESCRIPTION

- Black Rubber Grommet Designed for Rectangular Lights
- Provide Lamps with Additional Shock and Vibration Absorbency

Item #	Color	Pack	Carton
31516	Rectangular	1 Pc.	100/Carton

**Mini Rectangular Grommet**

DESCRIPTION

- Black Rubber Grommet Designed for Mini Rectangular Style Lights
- Provide Lamps with Additional Shock and Vibration Absorbency
- Fits Truck-Lite 45 Series Light

Item #	Color	Pack	Carton
31510	Mini Rectangular	1 Pc.	100/Carton

**Lens Guard - Turtle Back Marker Light**

DESCRIPTION

- Chrome Lens Guard for Turtle Back Clearance/Marker Light

Item #	Description	Pack	Carton
30003B	Chrome Die Cast	1 Pc.	20/Carton

**Lens Guard - Tiger Eye Marker Light**

DESCRIPTION

- Chrome Die Cast Lens Guard for Tiger Eye Clearance/Marker Light

Item #	Description	Pack	Carton
30001B	Chrome Die Cast	1 Pc.	20/Carton



Lens Guard - Rectangular Marker Light

DESCRIPTION

- Stainless Steel Lens Guard for Rectangular Clearance/Marker Light

Item #	Color	Pack	Carton
30002B	With Oval Cut Out	1 Pc.	100/Carton

**Mounting Bracket**

DESCRIPTION

- Mounting Bracket for Rectangular Clearance/Marker Light
- Available in 2 different Colors

Item #	Color	Pack	Carton
33006	Black	1 Pc.	100/Carton
30919	Chrome	1 Pc.	100/Carton

**Mounting Bracket**

DESCRIPTION

- Mounting Bracket for Rectangular Clearance/Marker Light
- Available for 1 Bulb Small Rectangular Clearance/Marker Light

Item #	Description	Pack	Carton
33003B	Black	1 Pc.	100/Carton
33002	Chrome	1 Pc.	100/Carton

**2" Light Bracket w/ Flange**

DESCRIPTION

- 2" Light Bracket
- Available in Stainless Steel or Black Powder Coated Steel

Item #	Material	Light Holes	Pack	Carton
20708	Stainless	1	1 Pc.	20/Carton
20725	Stainless	2	1 Pc.	20/Carton
34001	Steel/Black	1	1 Pc.	20/Carton



2 1/2" Light Bracket w/ Flange

DESCRIPTION

- 2 1/2" Light Bracket
- Available in Stainless Steel or Black Powder Coated Steel

Item #	Material	Light Holes	Pack	Carton
20436	Stainless	1	1 Pc.	20/Carton
20451	Stainless	3	1 Pc.	20/Carton
34004	Steel/Black	1	1 Pc.	20/Carton

**Oval Light Bracket**

DESCRIPTION

- Oval Light Bracket
- Available in Stainless Steel or Black Powder Coated Steel

Item #	Material	Light Holes	Pack	Carton
20401	Stainless	1	1 Pc.	20/Carton
20404	Stainless	2	1 Pc.	20/Carton
20407	Stainless	3	1 Pc.	20/Carton
20397	Stainless	4	1 Pc.	20/Carton
34014	Steel/Black	1	1 Pc.	50/Carton

**4" Light Bracket w/ Flange**

DESCRIPTION

- 4" Light Bracket
- Available in Stainless Steel or Black Powder Coated Steel
- Item # 34003 Does Not Come with Flange

Item #	Material	Light Holes	Pack	Carton
20422	Stainless	1	1 Pc.	20/Carton
20425	Stainless	2	1 Pc.	20/Carton
20428	Stainless	3	1 Pc.	20/Carton
34003	Steel/Black	1	1 Pc.	50/Carton
34007	Steel/Black	1	1 Pc.	50/Carton

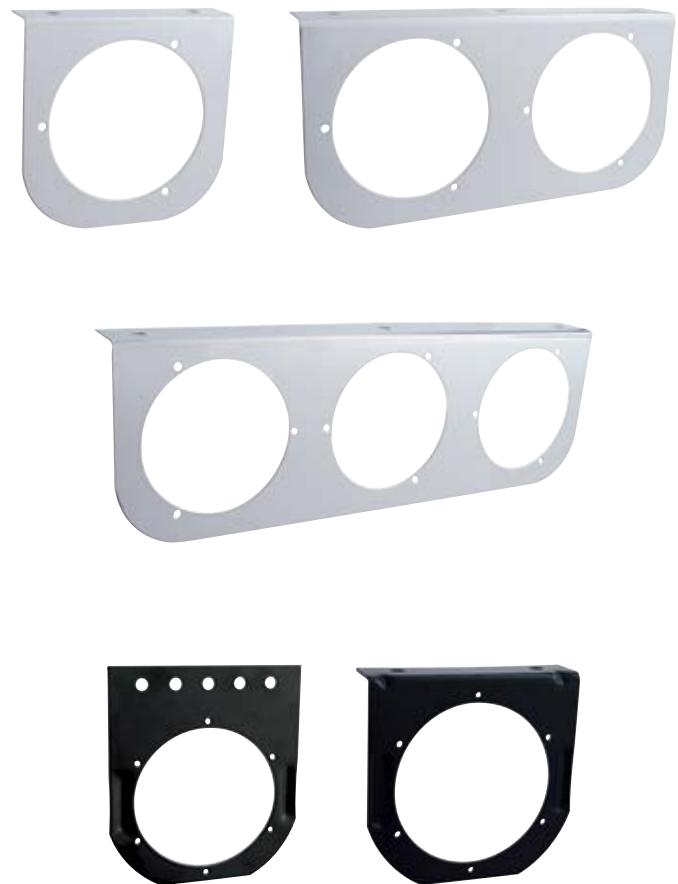



ELECTRICAL ACCESSORIES

Lead Wire, Molded .180

DESCRIPTION

- Single Lead Wires with .180 Bullet Termination and Stripped End
- 6" Lead Wires



Item #	Description	Pack	Carton
34213B	.180 Molded Male, Black	1 Pc.	100/Carton
34214B	.180 Molded Male, White	1 Pc.	100/Carton

Lead Wire, .180 Termination

DESCRIPTION

- Single Lead Wires with .180 Termination and Stripped End
- 6" Lead Wires



Item #	Description	Pack	Carton
34254	.180 Termination	1 Pc.	100/Carton

2 Wire Plug

DESCRIPTION

- 2 Wire Molded Plug
- Ground Wire with #10 Ring Termination
- Black (Hot) Wire with Stripped End

Item #	Description	Pack	Carton
34210	2 Wire Plug	1 Pc.	100/Carton

**2 Wire Plug**

DESCRIPTION

- 2 Wire Molded Plug
- Ground Wire with #10 Ring Termination
- Black (Hot) Wire with Stripped End

Item #	Description	Pack	Carton
34255	2 Wire Plug	1 Pc.	100/Carton

**2 Wire Plug**

DESCRIPTION

- 2 Wire Molded Plug
- Ground Wire with #10 Ring Termination
- Red (Hot) Wire Stripped End

Item #	Description	Pack	Carton
34211	2 Wire Plug	1 Pc.	100/Carton

**2 Wire Plug - Right Angle**

DESCRIPTION

- 2 Wire Molded Plug
- Ground Wire with #10 Ring Termination
- Red (Hot) Wire Stripped End

Item #	Description	Pack	Carton
34215	2 Wire Plug - Right Angle	1 Pc.	100/Carton

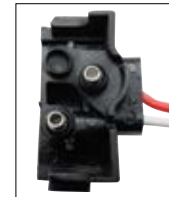
**2 Wire Plug**

DESCRIPTION

- 2 Wire Molded Plug Adaptor
- Ground Wire with #10 Ring Termination
- Red (Hot) Wire Stripped End

Item #	Description	Pack	Carton
34270	2 Wire Plug	1 Pc.	20/Carton

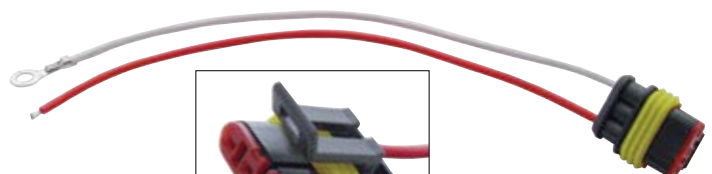

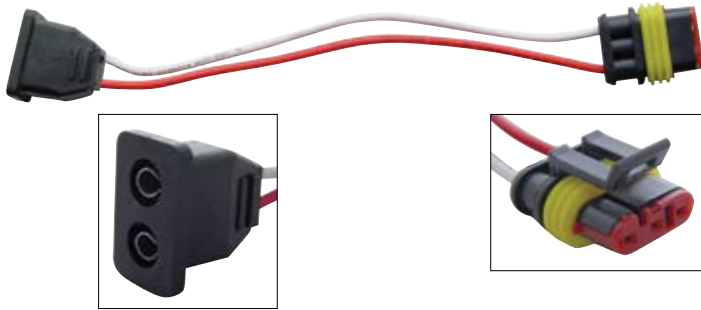
**2 Wire Adaptor**

DESCRIPTION

- Molded Plug Adaptor
- Female to Female Adaptor

Item #	Description	Pack	Carton
34271	2 Wire Adaptor	1 Pc.	20/Carton

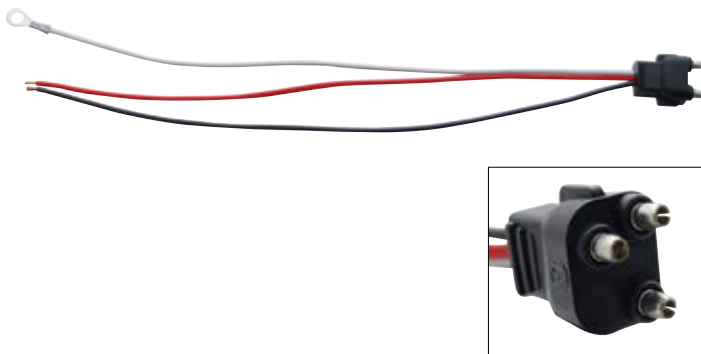
**3 Wire Plug**

DESCRIPTION

- 3 Wire Molded Plug
- White Ground Wire with #10 Ring Termination
- Black Wire (Tail/Clearance), Red Wire (Stop/Turn)

Item #	Description	Pack	Carton
34212	3 Wire Plug	1 Pc.	100/Carton

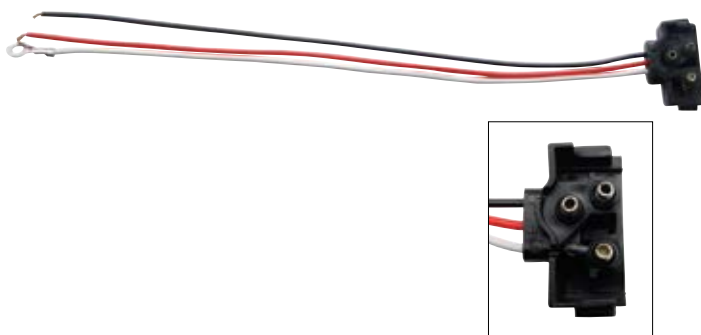
**3 Wire Plug - Right Angle**

DESCRIPTION

- 3 Wire Molded Plug
- White Ground Wire with #10 Ring Termination
- Black Wire (Tail/Clearance), Red Wire (Stop/Turn)

Item #	Description	Pack	Carton
34216	3 Wire Plug - Right Angle	1 Pc.	100/Carton

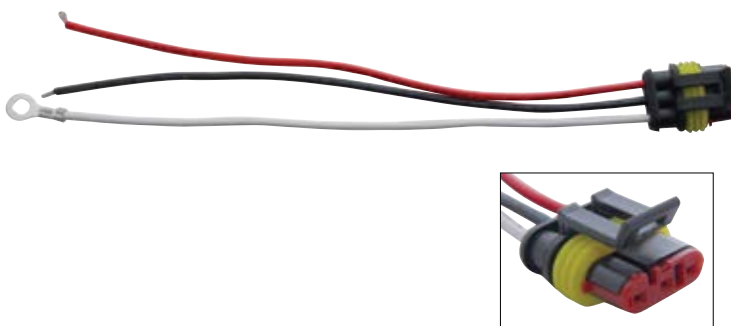
**3 Wire Plug**

DESCRIPTION

- 3 Wire Molded Plug
- White Ground Wire with #10 Ring Termination
- Black Wire (Tail/Clearance), Red Wire (Stop/Turn)

Item #	Description	Pack	Carton
34238	3 Wire Plug	1 Pc.	20/Carton

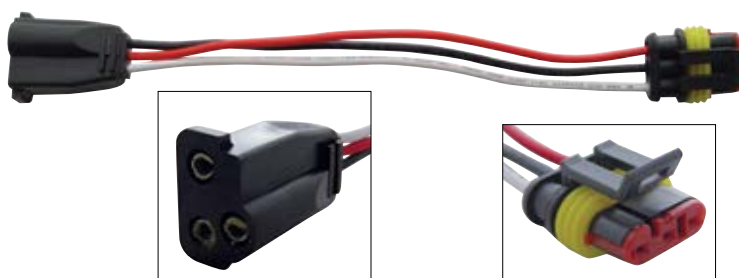
**3 Wire Adaptor**

DESCRIPTION

- Molded Plug Adaptor
- 3 Wire Molded Plug to 3 Contact Female Adaptor

Item #	Description	Pack	Carton
34236	3 Wire Adaptor	1 Pc.	1 Pc.

Double Bullet Plug Wire Harness

DESCRIPTION

- Double Bullet Plug Wire Harness
- Available in Rows of 124', 99', 74', and 66'
- Sold: **Bulk = 1 Pc.**

Item #	Plug	Lead	Length	Pack	Carton
34194	200	4"	66'	1 Roll	1/Carton
34195	150	6"	74'	1 Roll	1/Carton
34196	150	8"	99'	1 Roll	1/Carton
34193	150	10"	124'	1 Roll	1/Carton
34197	100	12"	99'	1 Roll	1/Carton

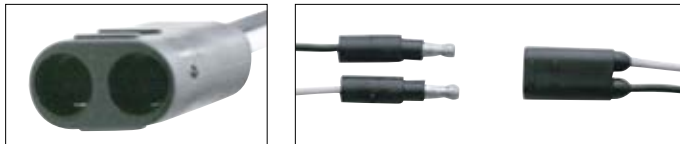

Wire Harness - 3 Wire Plug x 100' (12" Lead)

DESCRIPTION

- 12" Wire Lead
- 100 Molded 3 Wire Plugs
- Sold: **Bulk = 1 Pc.**

Item #	Description	Pack	Carton
34244	3 Wire Plug x100'	1 Pc.	1/Carton



Wire Harness - 3 Wire Plug (Right Angle) x 100' (12" Lead)

DESCRIPTION

- 12" Wire Lead
- 100 Molded 3 Wire Plugs
- Sold: **Bulk = 1 Pc.**

Item #	Description	Pack	Carton
34243	3 Wire Plug x100'	1 Pc.	1/Carton





100' Primary Wire Roll

DESCRIPTION

- 16G Primary Wire Rolls
- Available in 100' Rolls
- Sold: **Bulk = 1 Pc.**

Item #	Description	Pack	Carton
34118	Red	1 Pc.	1/Carton
34119	Black	1 Pc.	1/Carton
34120	White	1 Pc.	1/Carton



Wire Harness - 2 Wire Plug x 100' (12" Lead)

DESCRIPTION

- 12" Wire Lead
- 100' Long with 12" Lead, Approximately 100 Plugs
- Sold: **Bulk = 1 Pc.**

Item #	Description	Pack	Carton
34241	2 Wire Plug x 100'	1 Pc.	1/Carton



Wire Harness - 2 Wire Plug x 100' (6" Lead)

DESCRIPTION

- 6" Wire Lead
- 100' Long with 6" Lead, Approximately 200 Plugs
- Sold: **Bulk = 1 Pc.**

Item #	Description	Pack	Carton
34242	2 Wire Plug x 100'	1 Pc.	1 Pc.





ELECTRICAL ACCESSORIES

Round 7-Way Connector - Split Pin

DESCRIPTION

- 7-Way Male and Female Split Pin Connectors in Zinc Die Cast Housing
- Built-in Socket Slant Provides Easy Alignment and Maximum Contact
- Accepts Wide Range of Wire Gauges

Item #	Description	Pack	Carton
90500	7-Way Plug	1 Pc.	10/Carton
90501	7-Way Socket	1 Pc.	10/Carton



Round 4-Way Connector - Split Pin

DESCRIPTION

- 4-Way Male and Female Split Pin Connectors in Zinc Die Cast Housing
- Built-In Socket Slant Provides Easy Alignment & Maximum Contact

Item #	Description	Pack	Carton
90506	4-Way Plug	1 Pc.	10/Carton
90507	4-Way Socket	1 Pc.	10/Carton



Round 6-Way Connector - Split Pin

DESCRIPTION

- 6-Way Female Connectors in ABS Housing with PVC Boot
- 6-Way Male Connector in Chrome Plated Die Cast Housing
- Accepts Wide Range of Wire Gauges

Item #	Description	Pack	Carton
90504	6-Way Plug	1 Pc.	10/Carton
90505	6-Way Socket	1 Pc.	10/Carton





Round 7-Way Connector - Flat Pin

DESCRIPTION

- 7-Way Male and Female Flat Pin Connectors in ABS Black Housing
- Built-in Socket Slant Provides Easy Alignment and Maximum Contact
- Accepts Wide Range of Wire Gauges

Item #	Description	Pack	Carton
90502	7-Way Plug	1 Pc.	10/Carton
90503	7-Way Socket	1 Pc.	10/Cart



7 To 6-Way Harness Adaptor

DESCRIPTION

- Converts 7-Way Round Blade Connector to 6-Way Round Pin Connector
- Easily Adapts Tow Vehicle Connector to Trailer Connector
- Non-Corrosive Nylon Shell

Item #	Description	Pack	Carton
90602	7 To 6 Way Adaptor	1 Pc.	10/Carton



7 To 4-Way Harness Adaptor

DESCRIPTION

- Converts 7-Way Round Blade Connector to 4-Way Flat Connector
- Easily Adapts Tow Vehicle Connector to Trailer Connector
- Non-Corrosive Nylon Shell

Item #	Description	Pack	Carton
90601	7 To 4 Way Adaptor	1 Pc.	10/Carton



6 To 4-Way Harness Adaptor

DESCRIPTION

- Converts 6-Way Round Connector to 4-Way Flat Connector
- Easily Adapts Tow Vehicle Connector to Trailer Connector
- Non-Corrosive Nylon Shell

Item #	Description	Pack	Carton
90600	6 To 4 Way Adaptor	1 Pc.	10/Carton

Trailer Light Converter - 5 to 4 Wires

DESCRIPTION

- Converts 5-Wire System to 4-Wire System
- 18G Bonded Wire with Flat 4-Way Female Connector

Item #	Description	Pack	Carton
90620	5 to 4 Wire Converter	1 Pc.	10/Carton

**Trailer Light Converter - 4 to 3 Wires**

DESCRIPTION

- Converts 4-Wire System to 3-Wire System
- 18G Bonded Wire with 24" Wire on Each Side

Item #	Description	Pack	Carton
90621	4 to 3 Wire Converter	1 Pc.	10/Carton

**Trailer Light Converter - 3 to 2 Wires**

DESCRIPTION

- Converts 3-Wire System to 2-Wire System
- 18G Bonded Wire with 12" Wire on Each Side

Item #	Description	Pack	Carton
90622	3 to 2 Wire Converter	1 Pc.	10/Carton

**Trailer Light Converter**

DESCRIPTION

- 4 Pole Female Connector and Cover on One Side and 5 Wires on the other
- 18G Bonded Wire with 60" Wire Lead

Item #	Description	Pack	Carton
90623	4 Pole to 5 Wire Converter	1 Pc.	10/Carton

**Trailer Harness Kit**

DESCRIPTION

- Flat 4-Way Male Connector with 25 ft. Lead Wire

Item #	Description	Pack	Carton
90624	25' Harness Kit	1 Pc.	10/Carton

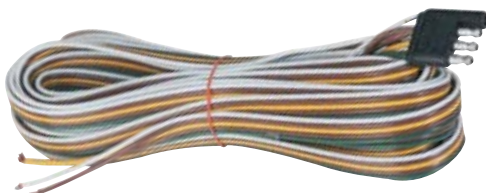
**Quick Splice Wire Connector**

DESCRIPTION

- Use for Quick Connections without Wire Stripping
- Design for Connecting 14 to 18 Gauge Wire in Non-Submersible Applications

Item #	Description	Pack	Carton
40108	Wire Connector	1 Pc.	1000/Carton



IMPORTANT NOTE: Every lamp, reflex reflector, and conspicuity treatment (device) must be permanently attached in the location specified below and must comply with all applicable requirements prescribed for it by FMVSS/CMVSS 108. The face of any device on the front/rear and sides should be, respectively perpendicular and parallel to vehicle centerline, unless it is photometrically certified at installation angle. No part of the vehicle shall prevent any device from meeting its prescribed requirements unless an auxiliary device meeting all prescribed requirements is installed.

In Canada: Manufacturers and importers of vehicles must have the proper certification test records demonstrating compliance of lighting components with all prescribed requirements.

BASIC EQUIPMENT REQUIRED ON ALL TRUCKS, BUSES & MPVs

DESCRIPTION				MANDATORY REQUIREMENTS			
Area	Equipment	(SAE Lens Coding)	Functional Purpose	QTY	Color	Location	Height mm (in.) from the ground
1	Headlamps - Lower Beam	(H, HR) Attention: US: "DOT" lettering required on lens Attention: US & Canada: light source code required on lens	Forward road illumination	Minimum 2	White	On the front - symmetrical - as far apart as practicable (If 4 lamp system - outboard or above upper beams)	560-1370 (22-54)
	Headlamps - Upper Beam	(H, HR) Attention: US: "DOT" lettering required on lens Attention: US & Canada: light source code required on lens	Forward road illumination	Minimum 2	White	On the front - symmetrical (If 4 lamp system - inboard or below lower beams)	560-1370 (22-54)
	Parking Lamps - Attention: Required only on vehicles less than 2032mm wide	(P)	Indicate parked vehicle	Minimum 2	White or Yellow	Front - symmetrical - as far apart as practicable	380-1530 (15-60)
	Daytime Running Lamps - Attention: for Canada required, for US optional.	(Y2) Attention: for US, "DRL" lettering required on lens if device is not headlamp	Indicate in-use vehicle	Minimum 2	White or Yellow	Front - symmetrical - as far apart as practicable	380 (15) minimum Maximum depends on type of DRL
	Front Turn Signal/Hazard Warning Lamps	(L)	Indicate direction of turn / identify disabled vehicle	Minimum 2	Yellow	Front - symmetrical - as far apart as practicable	380-2110 (15-83)
2	Front Clearance Lamps - Attention: Required for vehicles 2032mm wide or wider	(P2, PC* or P3*,PC2) *photometrically certified at installation angle	Show vehicle's width	Minimum 2	Yellow	At widest point - symmetrical - on the front or near the front - facing forward	As high as practicable
3	Front Identification Lamps (ID)	(P2 or P3)	Indicate presence of a wide vehicle	Exactly 3	Yellow	on the front - center - horizontally spaced 150 mm (6 in.) to 300 mm (12 in.) apart	As high as practicable or on top of cab
4A	Front Side Marker Lamps	(P2, PC* or P3 ,PC2*) *photometrically certified at installation angle	Front and Rear side marker lamps / side	Minimum 2	Yellow	Each side at front - as far forward as practicable	380 (15) minimum
4B	Front Side Reflex Reflectors	(A)		Minimum 2	Yellow	At front - symmetrical - as far forward as practicable - facing sideward	380-1530 (15-60)
5A	Rear Side Marker Lamps **	(P2, PC* or P3, PC2*) *photometrically certified at installation angle	Reflex reflector indicate vehicle's presence and length	Minimum 2	Red	Each side at rear - as far back as practicable	380 (15) minimum
5B	Rear Side Reflex Reflectors** ** not required on Truck Tractors	(A)		Minimum 2	Red	Each side at rear - as far back as practicable - facing sideward	380-1530 (15-60)
6	Rear Clearance Lamps Attention: Required for vehicles 2032mm wide or wider, but not required on Truck Tractors	(P2, PC* or P3, PC2*) *photometrically certified at installation angle	Show vehicle's width-MAY NOT be combined with tail lamps	Minimum 2	Red	At widest point - symmetrical - on the rear or near the rear - facing rearward	As high as practicable-may be lower only if rear ID lamps are at the top
7	Rear Identification Lamps (ID) - Attention: Required for vehicles 2032mm wide or wider, but not required on Truck Tractors	(P2 or P3)	Indicate presence of a wide vehicle	Exactly 3	Red	Rear - center - horizontally spaced 150 mm (6 in.) to 300 mm (12 in.) apart, facing rearward	in Canada : at the top - maybe lower if door header narrower than 25mm in USA: as high as practicable
8	Tail Lamps	(T)	Indicate vehicle's presence and width	Minimum 2	Red	On the rear - symmetrical - as far apart as practicable	380-1830 (15-72)
	Stop Lamps	(S)	Indicate braking	Minimum 2	Red	On the rear - symmetrical - as far apart as practicable	380-1830 (15-72)
	Rear Turn Signal/Hazard Warning Lamps	(L)	Indicate direction of turn/ identifies disabled veh.	Minimum 2	Red or Yellow	On the rear - symmetrical - as far apart as practicable	380-2110 (15-83)
	Rear Reflex Reflectors	(A)	Show vehicle's presence and width	Minimum 2	Red	On the rear - symmetrical - as far apart as practicable - facing rearward	380-1530 (15-60)
9	Backup Lamp	(R)	Illuminate ground behind the vehicle and alert road users	Minimum 1	White	Rear	No requirement
10	License Plate Lamp(s)	(L)	Illuminates license plate	Minimum 1	White	On the rear - above or at the sides of license plate	No requirement
11	Center High Mounted Stop Lamp - Attention: Required for vehicles less than 2032mm wide and 4536kg	(U3)	Indicates braking	Minimum 1	Red	On the rear - centerline of the vehicle	860 (34) minimum

ADDITIONAL EQUIPMENT FOR SPECIFIC VEHICLES

Vehicles 9.1 m (30 ft.) Long or Longer

DESCRIPTION				MANDATORY REQUIREMENTS			
Area	Equipment	(SAE Lens Coding)	Functional Purpose	QTY	Color	Location	Height mm (in.) from the ground
12A	Intermediate Side Marker Lamps	(P2 or PC)	Indicate presence of a long vehicle	Minimum 2	Yellow	Each side near center	380 (15) minimum
12B	Intermediate Side Reflex Reflectors	(A)	Indicate presence of a long vehicle	Minimum 2	Yellow	Each side near center - facing sideward	380-1530 (15-60)

Truck Tractors

MANDATORY REQUIREMENTS							
Area	Conspicuity Treatment	DOT Code	Quantity	Color	Location	Height	Options
13	Rear Upper Body Marking	DOT-C, DOT-C2, DOT-C3, or DOT-C4	Exactly 2 pairs of 300mm long strips	White	Rear upper corners of cab - facing rearward	As high as practicable excluding fairings	
14	Rear Marking	DOT-C, DOT-C2, DOT-C3, or DOT-C4	Indicate presence of a long vehicle	Red/White	Rear - facing rearward - on fenders, on mud flap brackets, or within 300mm below of the top of mud flaps	As horizontal as practicable and not higher than 1525 mm from the ground	If mud flaps not used - on the cab or frame mounted brackets

TRUCK, BUS, MPV EQUIPMENT LOCATION REQUIREMENT

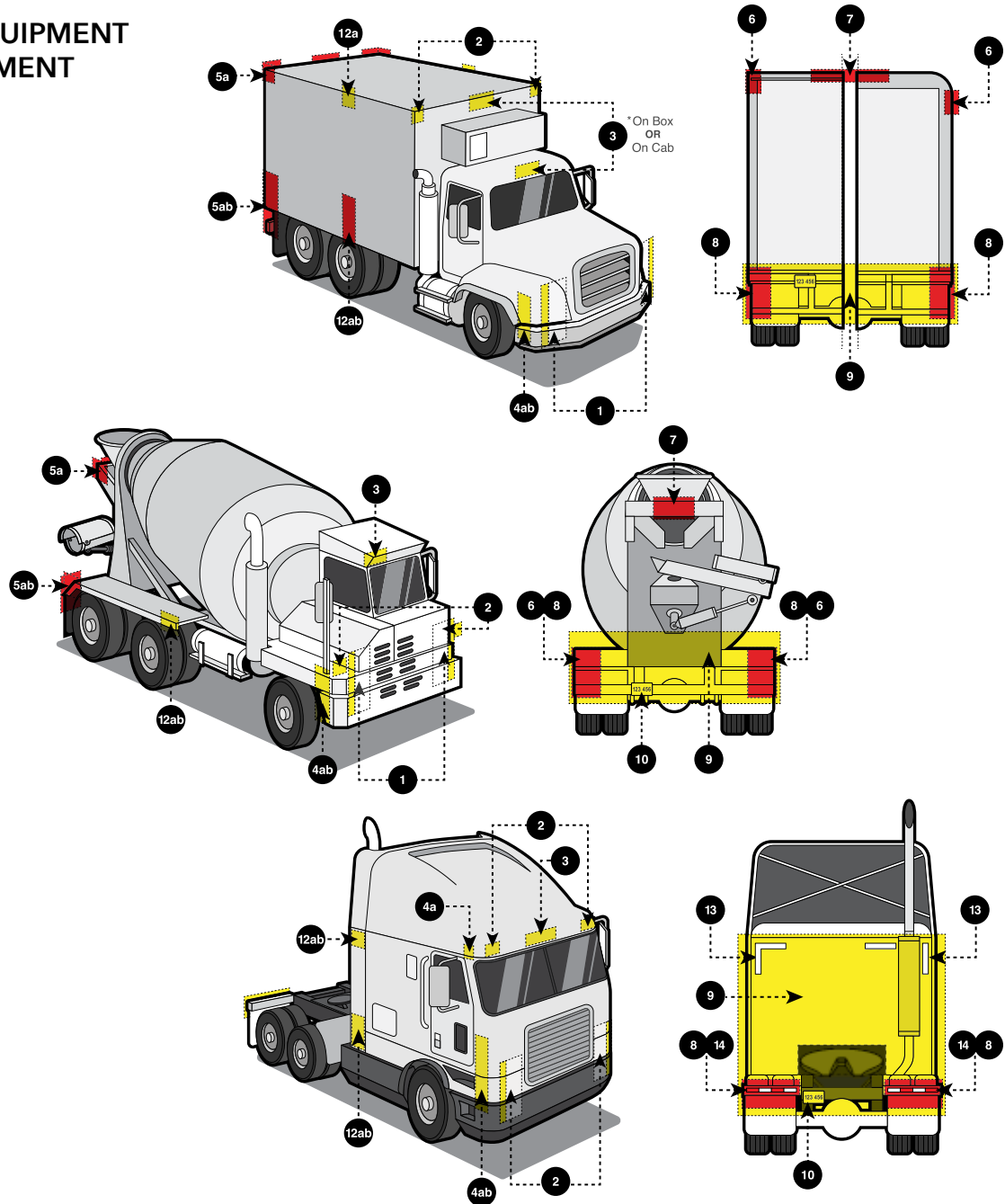

TRUCK, BUS, MPV EQUIPMENT LOCATION REQUIREMENT

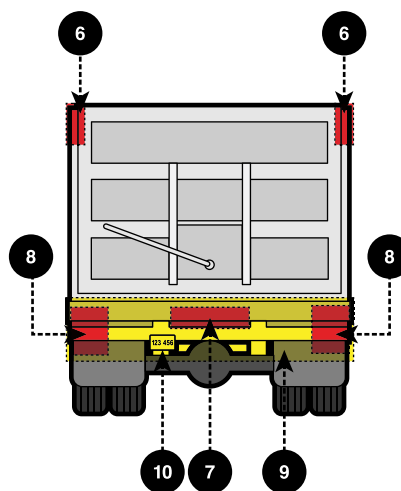
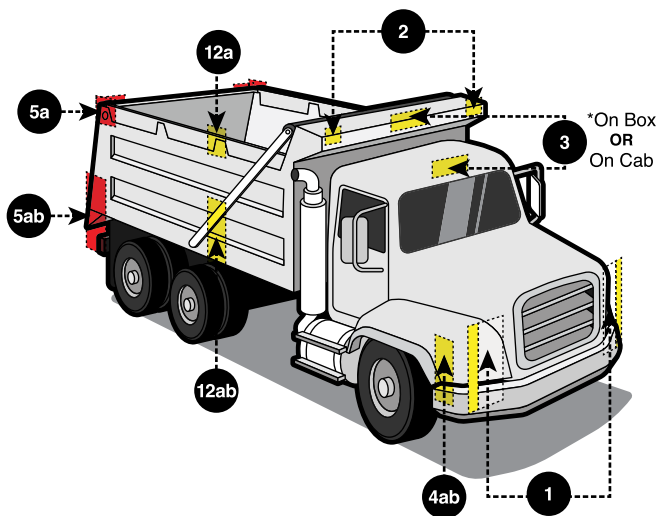
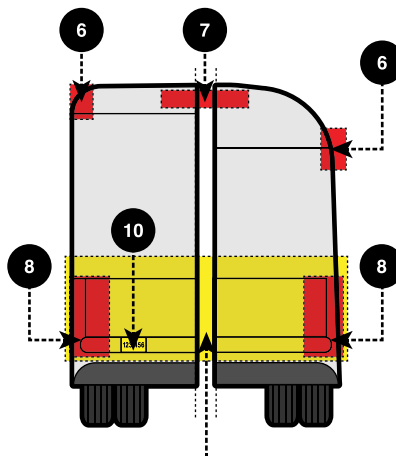
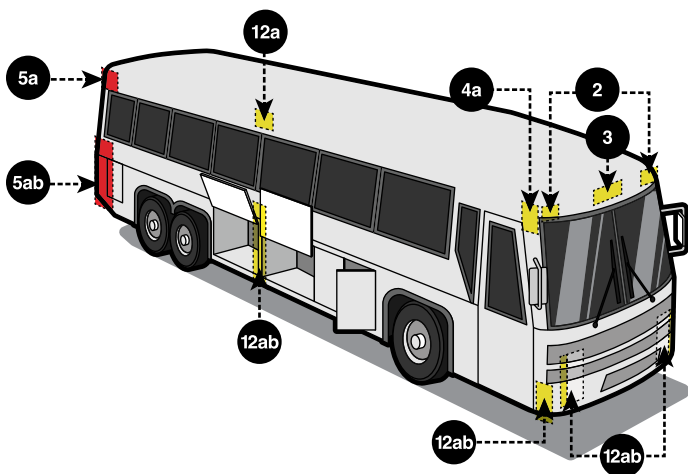
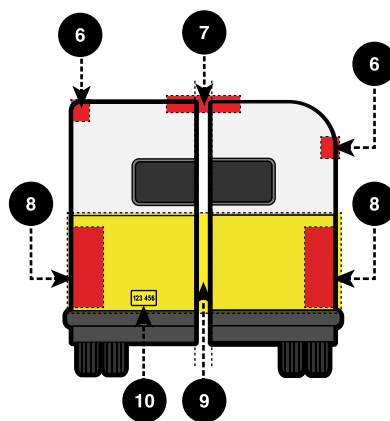
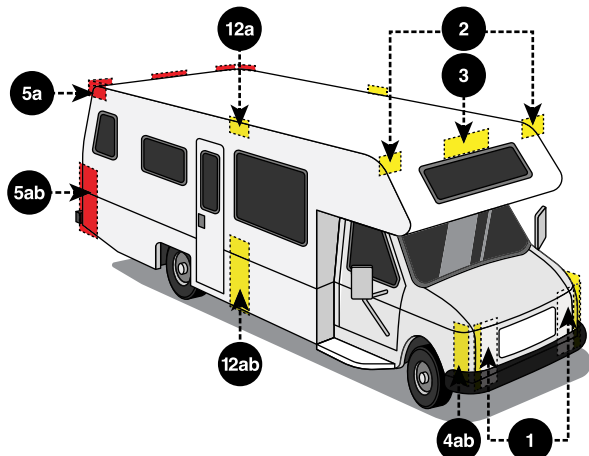
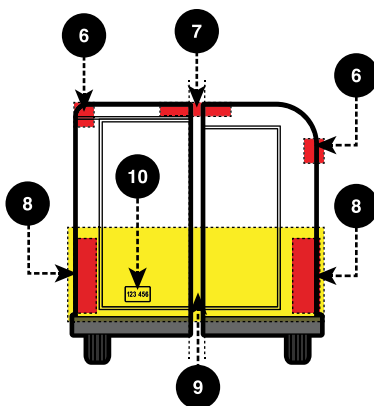
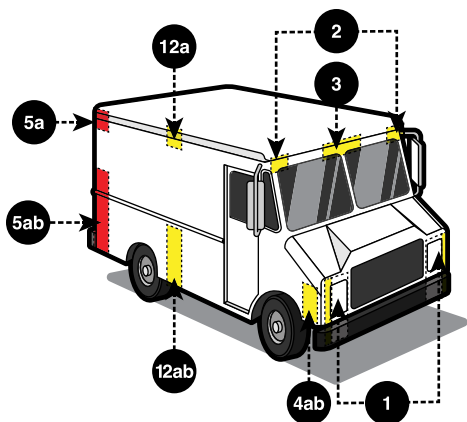

IMPORTANT NOTE: Every lamp, reflex reflector, and conspicuity treatment (device) must be permanently attached in the location specified below and must comply with all applicable requirements prescribed for it by FMVSS/CMVSS 108. The face of any device on the front/rear and sides should be, respectively perpendicular and parallel to vehicle centerline, unless it is photometrically certified at installation angle. No part of the vehicle shall prevent any device from meeting its prescribed requirements unless an auxiliary device meeting all prescribed requirements is installed.

In Canada: Manufacturers and importers of vehicles must have the proper certification test records demonstrating compliance of lighting components with all prescribed requirements.

BASIC EQUIPMENT REQUIRED ON ALL TRAILERS

DESCRIPTION				MANDATORY REQUIREMENTS			
Area	Equipment	(SAE Lens Coding)	Functional Purpose	QTY	Color	Location	Height mm (in.) from the ground
1	Tail Lamps	(T)	Indicate vehicle's presence and width	Minimum 2	Red	On the rear - symmetrical - as far apart as practicable	380-1830 (15-72)
	Stop Lamps	(S)	Indicate braking	Minimum 2	Red	On the rear - symmetrical - as far apart as practicable	380-1830 (15-72)
	Rear Turn Signal Lamps	(I)	Indicate direction of turn	Minimum 2	Red or Yellow	On the rear - symmetrical - as far apart as practicable	380-2110 (15-83)
	Rear Reflex Reflectors	(A)	Indicate vehicle's presence and width	Minimum 2	Red	On the rear - symmetrical - as far apart as practicable - facing rearward	380-1530 (15-60)
2	License Plate Lamp(s)	(L)	Illuminates license plate	Minimum 1	White	On the rear - above or at the sides of license plate	No requirement
3	Rear Side Marker Lamps	(P2, PC* or P3*,PC2) *photometrically certified at installation angle	Front and rear side marker lamps / side reflex reflectors indicate vehicle's presence and length	Minimum 2	Red	Each side at rear - as far back as practicable	380-1530 (15-60) no max. for veh. under 2.032m(80") wide
	Rear Side Reflex Reflectors	(A)		Minimum 2	Red	Each side at rear - as far back as practicable facing sideward	380-1530 (15-60)
4A	Front Side Marker Lamps	(P2, PC* or P3 ,PC2*) *photometrically certified at installation angle		Minimum 2	Yellow	Each side at front - as far forward as practicable	380 (15) minimum
4B	Front Side Reflex Reflectors	(A)		Minimum 2	Yellow	Each side at front - as far forward as practicable facing sideward	380-1530 (15-60)

ADDITIONAL EQUIPMENT FOR TRAILERS EXCEEDING THE FOLLOWING PARAMETERS

Length 9.1 m (30 ft.) or Longer

DESCRIPTION				MANDATORY REQUIREMENTS			
Area	Equipment	(SAE Lens Coding)	Functional Purpose	QTY	Color	Location	Height mm (in.) from the ground
5A	Intermediate Side Marker Lamps	(P2 or PC)	Indicate presence of a long vehicle	Minimum 2	Yellow	Each side near center - facing sideward	380 (15) minimum
5B	Intermediate Side Reflex Reflectors	(A)	Indicate presence of a long vehicle	Minimum 2	Yellow	Each side near center - facing sideward	380-1530 (15-60)

Width 2.032 m (80 in.) or Wider

DESCRIPTION				MANDATORY REQUIREMENTS			
Area	Equipment	(SAE Lens Coding)	Functional Purpose	QTY	Color	Location	Height mm (in.) from the ground
6	Rear Clearance Lamps	(P2, PC* or P3*,PC2) *photometrically certified at installation angle	Show vehicle's width - MAY NOT be combined with tail lamps	Minimum 2	Red	At widest point-symmetrical - on the rear or near the rear - facing rearward	As high as practicable - may be lower only if ID lamps are at the top
7	Rear Identification Lamps	(P2 or P3)	Indicate presence of a wide vehicle	Exactly 3	Red	On the rear-center, facing rearward - horizontally spaced 150 mm (6 in.) to 300 mm (12 in.) apart	in Canada : at the top - maybe lower if door header narrower than 25 mm in USA: as high as practicable
8	Front Clearance Lamps	(P2, PC* or P3*,PC2) *photometrically certified at installation angle	Show vehicle's width	Minimum 2	Yellow	At widest point-symmetrical - as far forward as practicable - facing forward	As high as practicable

Width 2.032 m (80 in.) or Wider and GVWR 4536 Kg (10,000 lb.) or More

DESCRIPTION		MANDATORY REQUIREMENTS					
Area	Conspicuity Treatment	DOT Coding	Quantity	Color	Location	Height	Options
9	Rear Upper Body Marking	DOT-C, DOT-C2, DOT-C3, or DOT-C4	Exactly 2 pairs of 300mm long strips	White	On the rear upper corners - facing rearward	At the top	Reflex reflectors may not be required if they are replaced, in their required location, with conspicuity treatment Optional in Canada Rear lower body and side conspicuity treatment may also be solid white, solid yellow, or white and yellow.
10	Bumper Bar Marking		Continuous	Red/White	On the rear bumper bar's horizontal element - full width - facing rearward	No requirement	
11	Rear Lower Body Marking		Continuous	Red/White (see options)	On the rear - full width of the vehicle - facing rearward	As horizontal as practicable and as close as practicable to the range of 375 to 1525 mm from the ground	
12	Side Marking		see location	Red/White (see options)	Each side - facing sideward - continuous, or evenly spaced over minimum of 50% of length, starts and ends as close to the front and rear or vehicle as practicable	As horizontal as practicable and as close as practicable to the range of 375 to 1525 mm from the ground	

TRAILER EQUIPMENT LOCATION REQUIREMENTS

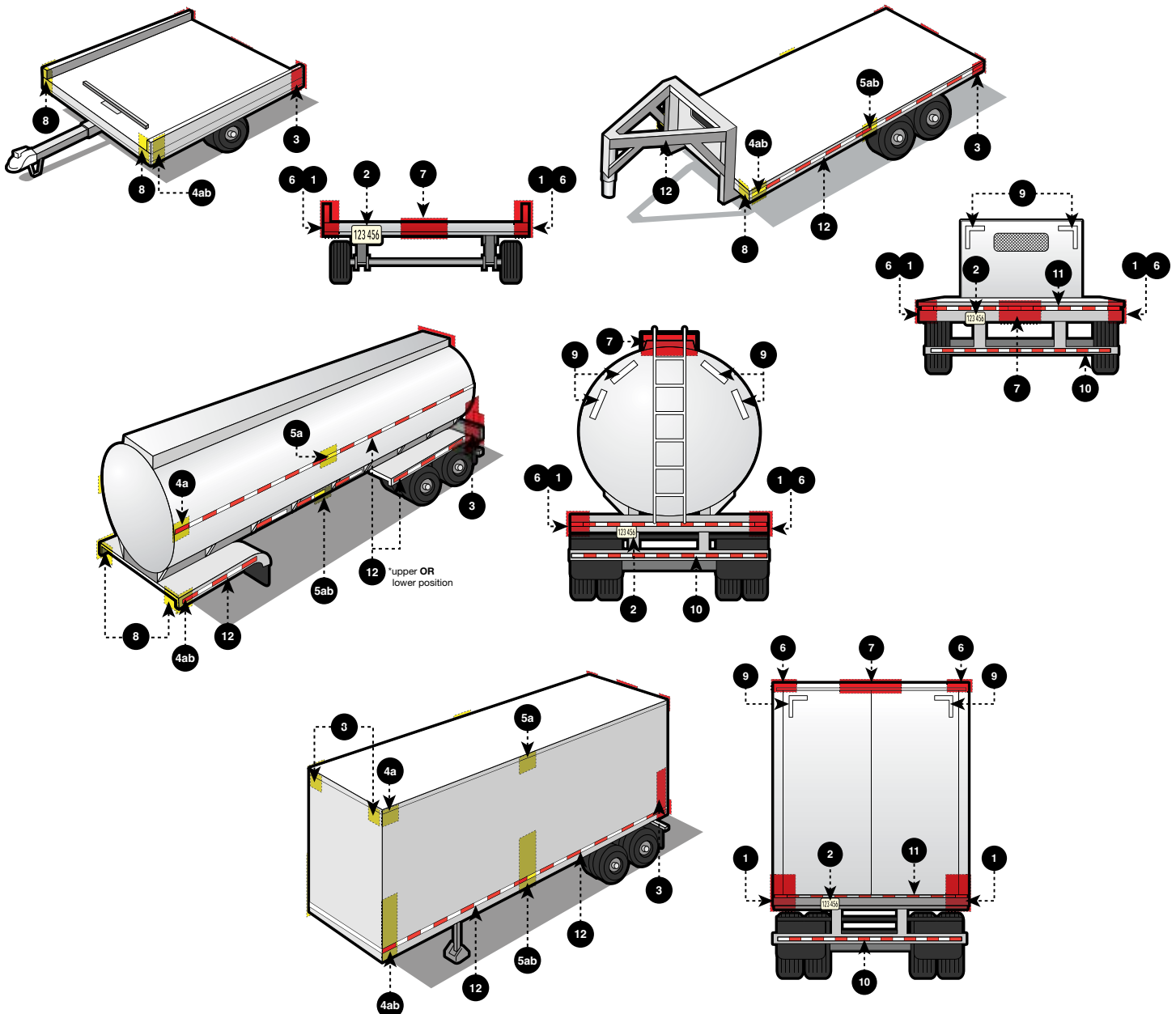

TRAILER EQUIPMENT LOCATION REQUIREMENTS

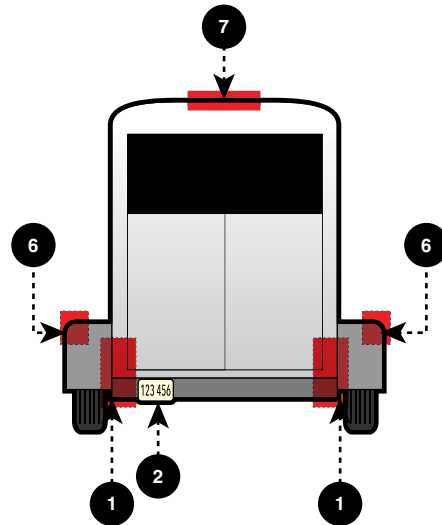
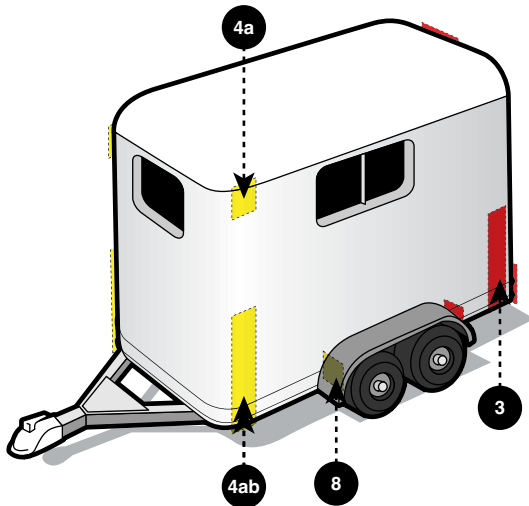
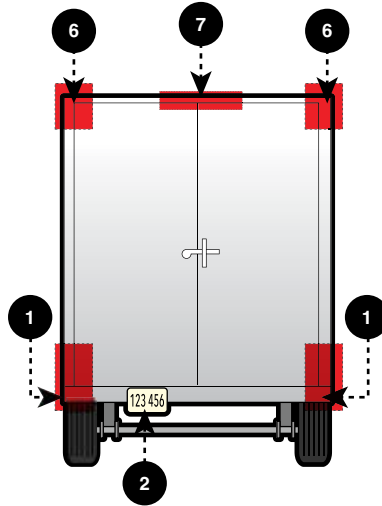
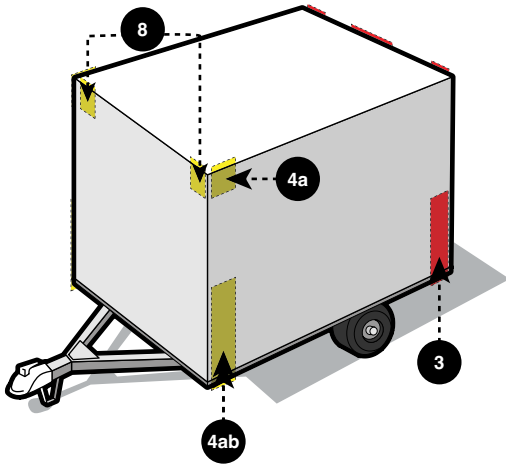
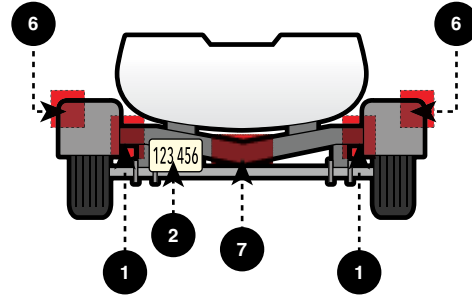
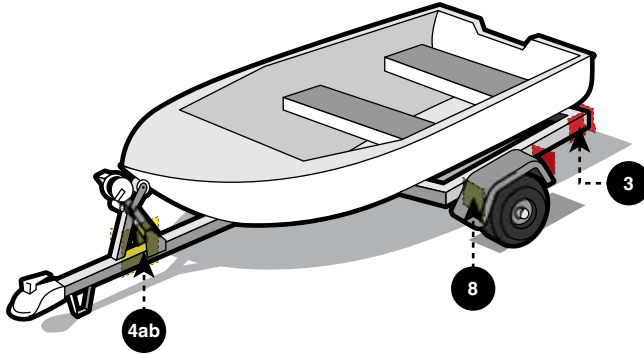
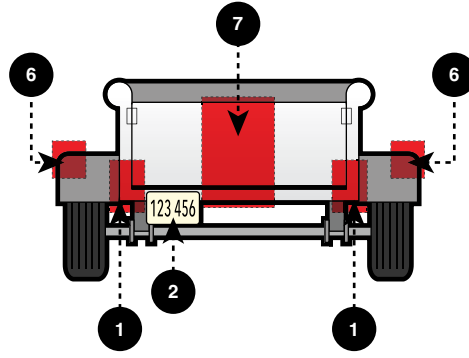
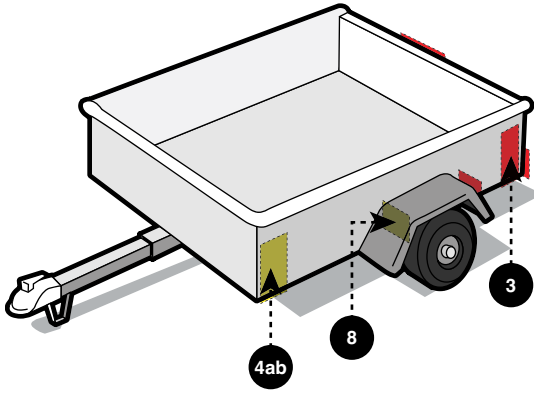

IMPORTANT: PLEASE REVIEW CAREFULLY**New Accounts**

Initial minimum buy-in is \$5,000 (or to be determined by United Pacific Industries, UPI hereafter). All initial orders must be prepaid in advance by Cashier's Check or VISA/MC. All new/potential accounts must complete a UPI "New Customer Info/Credit Form" and follow the Dealer Qualification Instructions. Upon completion of the credit application, approved accounts will be assigned payment terms of NET 30 Days (from invoice date). Accounts denied a credit line will be required to prepay in advance by Cashier's Check or VISA/MC.

Payment Terms:**Term Accounts**

Accounts with NET 30 Days terms are required to submit payment within the 30 days from the date of invoice. Acceptable forms of payment include checks, ACH (Automated Clearing House), or wire transfer.

A service charge of 1.5% per month will be imposed on invoices not paid within the 30 day term. Delinquent accounts will be required to pay Cash-In-Advance (CIA). Checks will be accepted but orders will not be released until the check is cleared by the bank. Past due invoices will delay current orders. Please check with UPI on your account status when placing an order.

Credit Cards

Accounts denied credit terms may pay by Visa or MasterCard. Credit card will be charged upon shipment. Credit card payments will not be accepted once an order has been shipped. UPI does not accept American Express or Discover card. A service fee of 3% will be charged on credit card orders.

COD

A \$12.50 fee will be assessed per COD box for all FedEx/UPS COD shipments. Truck COD shipment fees are to be determined later by trucking company.

Returned Checks:

A \$30 NSF (Non Sufficient Fund) fee will be assessed on each incidence a check is returned to UPI.

ORDERING GUIDELINES

Placing Orders: New orders may be placed by any of the following methods

1. Fax: (888) 986-5988
2. E-mail: sales@uapac.com
3. Telephone: In order to minimize errors, customers are encouraged to submit their orders by fax or email. Telephone orders should be limited to smaller orders such as add-ons to orders already submitted and/or fill-ins occurring between larger restocking orders.

Changes to Orders:

Whenever possible, revisions to orders - additions or deletions of items - should also be submitted via fax or email to reduce the possibility of errors.

Additions/Deletion of items will only be accepted within 48 hours after the initial order date and/or before 12:00PM on the date of the shipment. Additions of items placed after the 48 hours time period will be considered a new order and adhere to a new order freight prepaid policy. Deletions of item cannot happen after the 48 hours time period and/or after 12:00PM on the date of the shipment. Please note additions and/or deletions of items will delay the shipment date.

Canceling Orders:

Cancellation of orders must be submitted via fax or email within 24 hours of the order date. If the order has already shipped it will be the customers responsibility to return the order at the customers own expense. A restocking fee may apply, please see "Return" policy for further detail.

Backorders:

Customers have the option of having their backorders shipped or cancelled. Backorders resulting from a freight prepaid qualifying order will be shipped freight prepaid. UPI reserves the right to cancel backorders that are 6 months or older from the initial invoice date.

Minimum Order:

A minimum order of \$50.00 is required. Orders below \$50.00 will be assessed a minimum order fee of \$10.00.

Packaging:

A 10% service charge will be added to orders with special packaging or UPC barcoding requirements.

Lead Times:

Standard lead time for all United Pacific orders is 1-3 business days from the receipt of the purchase order. Larger orders may require a lead time of up to 5 business days. Transit time of 3-5 business days must be considered when placing orders. UPI cannot be responsible for delays in shipment after an order leaves our warehouse. UPI will work to resolve delays with freight

forwarding firms, however, delays do arise from time to time due to weather and unforeseen circumstances beyond UPI's control. Express order are exempted; please view Freight/Shipping Policy for further detail.

Order Confirmation:

United Pacific will acknowledge receipt of orders by email/fax/telephone within 1 business day of receipt. If confirmation is not received, please contact UPI to ensure your order was received.

FREIGHT**Prepaid Freight:**

Stock orders between \$50 and \$999.99 (US Lower 48 States), **\$50 and \$2499.99 (Alaska and Hawaii)**, **\$50 and \$1499.99 (Canada)**, [all price net US\$], will be shipped FOB Long Beach, California. Stock orders of \$1,000 (US Lower 48 States), **\$2500 (Alaska and Hawaii)**, **\$1500 (Canada)**, [based on UPI current pricing], or more will be shipped Freight Prepaid Ground to a single location only. (See exception for Oversize Items*). *Express Air orders, Special Net Pricing orders, and Special Quote Pricing orders are excluded.* United Pacific reserves the right to select the carrier of our choice. Customers may select the carrier of their choice at their own expense, negotiated rates and insurance. Special handling charges such as lift gate fee, residential delivery fees are not included in the prepaid freight policy. If customers elect to choose their own freight carrier, orders will be shipped via FREIGHT COLLECT.

Will Call Orders:

Will Call orders can be picked up 2 - 4 hours after placing the order. Customers should always call ahead to confirm when order will be ready to pick up.

IMPORTANT: PLEASE REVIEW CAREFULLY**SHIPPING POLICY****International Shipments:**

Shipments to locations outside the continental United States will be shipped to the customer's shipping agent or broker within the continental United States in accordance with the US freight policy. International customers will be responsible for the duties and taxes of their respective country.

Express Orders:

All express orders, such as Next Day, Second Day, 3 Day Service & Will Call, must be faxed/mailed. Order confirmation will be faxed to the customer for final approval. If confirmation is not received, please contact UPI to ensure your order was received. Customers are required to sign off on express orders and fax confirmation back to UPI. Cut off for express order is 12:00PM. Express orders received after 12:00PM may or may not ship the same day. Please call UPI to confirm projected shipping date or will call time.

Due to the high cost of express shipments, customer may request UPI to call to confirm freight charges. If customer does not request confirmation, UPI will ship the express order.

Drop Shipments:

All drop shipment orders will be assessed a \$10.00 processing fee. Drop shipment processing fee will be automatically added to the invoice without notice. All drop shipment orders must be faxed in. No freight allowance or prepaid freight will be permitted for any drop shipments, thus, all drop ship orders, regardless of order size, are FOB Long Beach, CA.

CLAIMS**General Policy:**

All claims (Shortage, Mis-Shipped, Damage, Overage, Customer Error & Billing Error) must be submitted to UPI within 3 business days of the receipt of shipment. Claims submitted beyond 3 business days of the receipt of shipment will be voided by UPI.

On all shipments, the person who signs and receives the shipment is responsible for noting on the Bill of Lading, in writing, whether any boxes arrived damaged or shorted. Failure to do so will void all claim rights between all parties. UPI will have no recourse against the trucking company if customer does not note any damages or shortages on the Bill of Lading.

The customers receiving department must count and sign for the exact number of boxes received. Failure to follow the above instructions will void all claim rights between all parties.

Shortages / Mis-Ships / Damages

While UPI strives to fill every order with 100% accuracy, on occasion an item may get shipped in error or get damaged during shipping. In the event this occurs, please follow the process below. Note: This type of claim must be reported to UPI within three (3) business days of receiving the order.

1. Contact the United Pacific office to initiate the claim. To make it easy for you we have two acceptable methods for requesting the claim:

* By e-mail : returns@uapac.com

* By fax : (888) 986-5988

*** Note: To ensure you receive a timely credit, we cannot accept claim requests by phone.**

2. You will be required to provide the following information:

* Your business name

* Contact name and telephone number (in case we have questions)

* Date the order was received

* A copy of the Packing List / Invoice noting the item number and quantity that was shipped in error or damaged during shipping.

* Special instructions you have for us.

3. UPI will send a return label so you can ship the items back.

4. Once we receive the miss-shipped/damaged item(s) a credit will be issued to your account on the next billing cycle.

5. Shortages will be credit to the Customers' account, unless customer would like the shortages replaced.

Overages:

UPI strives to provide our customers with the best customer service and products, in turn we would greatly appreciate any help from customer in notifying UPI of any shipping overages. Customers will be offered the option of retaining the merchandise or returning the merchandise to UPI at UPI's expense. If the items are to be returned, an RMA number and return shipping label will be provided.

Customer Errors:

Any item or quantity ordered in error by the customer may be returned by contacting UPI for a RMA No.

1. To make it easy for you we have two acceptable methods for requesting the RMA:

* By e-mail: returns@uapac.com

* By fax: (888) 986-5988

*** Note: To ensure you receive a timely RMA credit, we cannot accept RMA requests by phone.**

2. You will be required to provide the following information.

* Your business name

* Contact name and telephone number (in case we have questions)

* A list of the items number and quantity ordered in error

* Special instructions you have for us

3. UPI will review the request to ensure the products are within the return period.

4. Once we have validated the request, United Pacific will issue an RMA number to the customer. In issuing the RMA approval, the following conditions will apply :

* Returned items are subject to a 20% re-stocking fee.

* Return shipping costs are the responsibility of the customer.

* Items must not have any retail/price sticker on exterior packaging or they will be returned to the customer at customer's expense and no credit given.

* Items must be in good condition with original packaging intact or they will be returned to the customer at customer's expense and no credit given.

* Allow up to 30 days for the credit to be issued from the time the returned items are received.

Billing Errors:

Billing errors should be reported to UPI within 3 business days of invoice receipt. Customers are asked to provide the invoice number, part number, and quantities in question. Once verified, UPI will issue a credit or an invoice for the difference in billing error.

IMPORTANT: PLEASE REVIEW CAREFULLY**WARRANTY POLICY****General Policy:**

UPI offers a NO HASSLE WARRANTY RETURN policy to all our customers. Warranty claims can only be submitted through an authorized UPI Distributor. UPI warranty is not transferable and applies to the original installation and purchase only. In no event shall UPI be liable for incidental or consequential damages, nor shall UPI be liable for any claims or damages arising out of or connected with the UPI warranty exceed the purchase price of the products. There are no warranties, expressed or implied (including any warranty of merchantability or fitness) that extend beyond this warranty. The warranty does not apply to costs associated with the loss of use of the product, loss of time, inconvenience, commercial loss, incidental or consequential damages. UPI reserves the right to alter the designs of products without assuming any obligation to modify previously manufactured products and will only replace warranted products with redesigned products.

Warranty does not apply to merchandise that has been drilled, cut, welded, modified in any way or installed contrary to normal installation and usage. In addition, UPI cannot be held liable for damages caused by road hazards, accidents, misuse, neglect, abuse or corrosive environments including acid washes and highway snow/ice chemicals which can cause discoloration and corrosion in aluminum, chrome, stainless steel and light products. UPI reserves the right to credit returned merchandise at the initial purchase price or at the current selling price, which price ever is lower.

Aluminum / Chrome / Stainless Steel Products:

All aluminum, chrome, and stainless steel products carry a limited 6 month warranty (from invoice date) against defects in material or workmanship.

Lighting Products:**Incandescent**

All incandescent lighting products carry a limited 12 month warranty (from invoice date) against defects in material or workmanship. The limited 12 month warranty does not apply to several applications, such as, buses, construction equipment, and off road vehicles.

LED

All LED lighting products carry a specific Limited* Warranty (from invoice date) against defects in material or workmanship.

- * LED Marker, 2", 2-1/2", 4", 7", Oval & Square Lights - Varies from 2 years to 10 years to Limited Lifetime, depending on specific item. The housing, bezel or mounting base on any light made from Chrome/Stainless carries a 6 month limited warranty.
- * LED Cab Lights and Kits, Double/Single Stud Turn Signal and PB/KW/FL/VL or non-make Turn Signals and any/all Strip Lights - Varies from 2 years to 10 years to Limited Lifetime, depending on specific item. The housing, bezel or mounting base on any light made from Chrome/Stainless carries a 6 month limited warranty.
- * LED Beacon, Driving, Headlights, Work & Warning Lights - Varies from 6 months to 3 years. The housing, bezel or mounting base on any light made from Chrome/Stainless carries a 6 month limited warranty.
- * All LED Accessory Lights (Honda, Stainless Steel Double/Single face Lights, Interior Lights, License Plate Lights, and any Accent Lights. The housing, bezel or mounting base on any light made from Chrome/Stainless carries a 6 month limited warranty.

RETURNS**General Policy:**

All returns must be authorized by UPI. All return requests must be faxed or e-mailed (returns@uapac.com) A RMA number (Return Merchandise Authorization Number) will be provided. Returns not possessing a valid RMA number are subject to rejection and will be returned to sender at the

customer's expense.

All customers are encouraged to use the Warranty RMA Claim Form.

Defective Goods / Warranty Return:

UPI offers our customers a No Hassle Warranty Return. Please follow the instructions below for requesting a RMA for defective goods:

1. If any warranty issues occur, simply contact the UPI for RMA number
To make it easy for you we have two acceptable methods for requesting the RMA:
 - * By e-mail: returns@uapac.com
 - * By fax: (888) 986-5988
 - * **Note: To ensure you receive a timely RMA credit, we cannot accept RMA requests by phone.**
2. You will be required to provide the following information:
 - * Your business name
 - * Contact name and telephone number (in case we have questions)
 - * A list of the defective item number and quantity with the nature/ reason of the defect
 - * Special instructions you have for us
 - * The enclosed fax form may be used for your convenience to request an RMA
3. UPI will review the request to ensure the products are within the stated warranty period.
4. Once we have validated the warranty items, a RMA confirmation, listing the items and cost will be faxed to the customer within 3 business days. UPI will process the credit to your account within 30 days.

Note: There will be no need to return the warranty product to us. However, from time to time, UPI may require some warranty products to be shipped back so we may analyze the cause of the failure. All warranty products that are required to be shipped back will be freight prepaid by UPI.

Stock Return

United Pacific Industries encourages all customers to regularly monitor the sales volume and stock level of their inventory items. As sales trends may slow the movement of specific items, our hope is that those items are featured as "close-out specials" as to minimize stock returns. We also understand that the customer, from time to time, may accumulate over-stock items and desire to return those. Therefore, we have adopted the following policy below.

NOTE:

- * Items must have been purchased by the dealer requesting the stock return.
- * Items must have been purchased within the preceding 12 months.
- * Items that have been discontinued will not be considered for return.

1. Contact the United Pacific office for RMA number We have 2 acceptable methods for requesting the RMA:
 - By e-mail : returns@uapac.com
 - By fax : (888) 986-5988
 - ***Note: To ensure you receive a timely RMA credit, we cannot accept RMA requests by phone.**
2. You will be required to provide the following information:
 - * Your business name
 - * Contact name and telephone number (in case we have questions)
 - * A list of defective items: Item numbers and quantity of each
 - * Special instructions you have for us
3. Your claim will be reviewed within 5 business days and you will be contacted by your sales representative who will discuss solutions to liquidate these slow moving items.

Item #	Pg #	Item #	Pg #	Item #	Pg #	Item #	Pg #	Item #	Pg #
10500B	58	30719	57	31321AK	48	34238	65	36702	41
10501B	58	30720	57	31361	47	34241	67	36763	4, 37
10518B	58	30723	57	31361AK	47	34242	67	36764	4, 37
10519B	58	30724	57	31362	47	34243	66	36765	4, 37
20397	62	30725	56	31362RK	47	34244	66	36766	4, 37
20401	62	30726	56	31364	47	34254	63	36767	4, 37
20404	62	30727	57	31364RK	47	34255	64	36768	4, 37
20407	62	30728	57	31401	54	34270	64	36774B	3, 13
20422	62	30911	41	31402	55	34271	65	36774BARK-B	3, 13
20425	62	30911RK	41	31427	55	36008	44	36781	5, 38
20428	62	30913	41	31503	59	36012	44	36782	5, 38
20436	62	30918	41	31504	59	36013	44	36783	5, 38
20451	62	30919	61	31505	59	36014	45	36784	5, 38
20708	61	31039	53	31506	59	36015	45	36785	5, 38
20725	61	31050	43	31507	59	36016	45	36786	5, 38
30001B	60	31050ARK-B	43	31508	59	36017	45	36854	36
30002B	61	31050ARK-C	43	31510	60	36020	45	36855B	2, 18
30003B	60	31055	42	31515	59	36021	45	36855BRK	2, 18
30005	43	31055AK	42	31516	60	36379	48	36922B	1, 15
30008	43	31059	42	33002	61	36409	47	36922BRK	1, 15
30020	44	31059RK	42	33003B	61	36409AK	47	36923B	1, 15
30023	44	31061	42	33006	61	36410	52	36923BAK	1, 15
30051	43	31061AK	42	33130	50	36410CK	52	36924B	1, 19
30051AK-B	43	31065	42	33131	50	36451	55	36924BRK	1, 19
30051AK-C	43	31065RK	42	33133	50	36634	5, 38	36925B	1, 19
30055	43	31076	51	33135	50	36635	5, 38	36925BAK	1, 19
30055RK-B	43	31077	51	33136B	53	36636	5, 38	36957B	1, 17
30055RK-C	43	31078	51	33137	54	36637	5, 38	36958B	1, 17
30101	44	31079	51	33138	54	36638	5, 38	36961B	20
30102	44	31080	51	33139	54	36639	5, 38	36961BAK	20
30141	44	31081	43	34001	61	36640	4, 37	36962B	20
30141AK-C	44	31101	46	34003	62	36641	4, 37	36962BRK	20
30143	53	31101AK	46	34004	62	36642	4, 37	36965	31
30145	44	31106	52	34007	62	36643	4, 37	36968B	10
30145RK-B	44	31106CK	52	34014	62	36644	4, 37	36969B	10
30145RK-C	44	31109	46	34118	67	36646	4, 38	36972B	11
30168	42	31109RK	46	34119	67	36647	4, 38	36973B	11
30169	42	31123	46	34120	67	36648	4, 38	36976B	11
30191	41	31125	47	34193	66	36649	4, 38	36977B	11
30191AK	41	31126	47	34194	66	36650	4, 38	36980B	10
30361	54	31131	49	34195	66	36651	4, 38	36981B	10
30362	53	31132	49	34196	66	36668	3, 24	36984B	10
30701	57	31133	49	34197	66	36669	3, 24	36985B	10
30703	57	31134	49	34210	64	36670	3, 24	36988B	10
30704	57	31135	49	34211	64	36671	31	36989B	10
30709	57	31136	49	34212	65	36672	35	36992B	11
30710	57	31165	48	34213B	63	36679B	2, 27	36993B	11
30711	57	31166	48	34214B	63	36679BCK	2, 27	37008B	26
30712	57	31251	52	34215	64	36680B	2, 26	37008BCK	26
30713	56	31251CK	52	34216	65	36680BCK	2, 26	37009B	27
30714	56	31321	48	34236	65	36701	41	37009BCK	27

Item #	Pg #	Item #	Pg #	Item #	Pg #	Item #	Pg #
37016B	8	38159BRK-B	14	38660BCK	27	39821B	16
37016BAK	8	38161B	14	38661B	28	39821BRK	16
37017B	8	38161BAK-B	14	38661BCK	28	39901	34
37017BRK	8	38162B	14	38746B	21	39901B	34
37033B	23	38162BAK-B	14	38746BAK	21	39904B	13
37034B	23	38165B	13	38747B	21	39905B	13
37035B	6	38166B	13	38747BRK	21	39910B	8
37035BAK	6	38168B	8	38770B	17	39910BAK	8
37036B	6	38169B	8	38770BRK	17	39911B	8
37036BAK	6	38170B	7	38771B	17	39911BRK	8
37074	32	38170BAK	7	38771BAK	17	39918B	14
37079B	25	38171B	7	38778B	28	39918BAK-B	14
37080B	25	38171BRK	7	38778BCK	28	39919B	14
37087	32	38176B	9	38828B	30	39919BRK-B	14
37088	36	38176BAK	9	38828BCK	30	39924B	17
37089B	25	38177B	9	38849B	6	39924BRK	17
37090B	25	38177BRK	9	38849BAK	6	39930B	29
37123	33	38191B	12	38850B	6	39931B	30
37123B	33	38192B	12	38850BRK	6	39960B	23
37128B	19	38225B	12	38900B	20	39961B	23
37128BRK	19	38226B	12	38901B	20	39973B	17
37129B	19	38258B	12	38920B	20	39973BAK	17
37129BAK	19	38259B	12	38920BAK	20	39979	33
37132B	15	38310B	22	38936B	39	39984B	7
37132BRK	15	38311B	22	39117B	2, 16	39984BAK	7
37133B	15	38395B	28	39117BRK	2, 16	39985B	7
37133BAK	15	38409B	7	39119B	2, 16	39985BRK	7
37157	36	38409BAK	7	39119BAK	2, 16	39990B	25
37157B	36	38411B	7	39343B	16	39993	34
37174B	34	38411BRK	7	39343BAK	16	39994B	29
37175B	34	38455B	3, 9	39353B	21	39995B	29
37552B	37	38455BAK	3, 9	39354B	21	39998B	28
37562	31	38456B	3, 9	39398B	11	39998BCK	28
37563	33	38456BRK	3, 9	39399B	11	40108	70
37597	35	38457B	7	39440B	16	90500	68
37598	35	38457BAK	7	39440BRK	16	90501	68
37622	35	38458B	7	39455B	22	90502	69
37622B	35	38458BRK	7	39456B	22	90503	69
37625B	39	38463B	25	39510B	30	90504	68
37626B	39	38465B	9	39510BCK	30	90505	68
38030B	29	38465BAK	9	39551B	22	90506	68
38031B	30	38466B	9	39552B	22	90507	68
38061B	18	38466BRK	9	39656B	18	90600	69
38116B	17	38469B	25	39688	32	90601	69
38116BRK	17	38473B	23	39688B	32	90602	69
38121B	19	38474B	23	39739B	9	90620	70
38121BRK	19	38479B	3, 25	39739BAK	9	90621	70
38143B	23	38490B	21	39740B	9	90622	70
38143BAK	23	38491B	21	39740BRK	9	90623	70
38158B	14	38551B	27	39767B	6, 14	90624	70
38158BAK-B	14	38551BCK	27	39768B	6, 14		
38159B	14	38660B	27	39772B	6, 14		





truck.uapac.com

3788 E. Conant St., Long Beach, CA 90808

F: 888.986.5988

T: 800.790.6988

E: sales@uapac.com

 Like us on Facebook: www.facebook.com/uapac.truck/

UCOEM2
OEM LIGHTING CATALOG
- 2ND EDITION



710270095292